

RAH MC VS U KP

OUTDOOR MONOBLOCK CHILLERS AIR CONDENSED EQUIPPED WITH SCREW COMPRESSORS AND AXIAL FANS

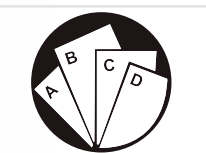

Multiple instructions:
 Consult the specific part



Read and understand
 the instructions before
 undertaking any work on
 the unit

RETAIN FOR FUTURE REFERENCE

Reproduction, data storage and transmission, even partial, of this publication, in any form, without the prior written authorisation of the Company, is prohibited. The Company can be contacted for all inquiries regarding the use of its products.

The Company follows a policy of continuous product development and improvement and reserves the right to modify specifications, equipment and instructions regarding use and maintenance at any time, without notice.

Declaration of conformity

We declare under our own responsibility that the below equipment complies in all parts with the CEE and EN directives.

The declaration of conformity is enclosed to the technical booklet enclosed with the unit.

INDEX

1. INTRODUCTION	5
1.1 Preliminary information	5
1.2 Aim and content of the manual	5
1.3 How to store this manual	5
1.4 Manual updates	5
1.5 How to use this manual	5
1.6 Potential risks	6
1.7 General description of symbols used.....	7
1.8 Safety symbols used.....	8
1.9 Limitations and prohibited use	8
1.10 Unit identification	9
2. SAFETY	10
2.1 Warning re potentially hazardous toxic substances	10
2.2 Refrigerant handling	12
2.3 Prevention of inhalation of high vapor concentrations	12
2.4 Procedures in the event of accidental release of refrigerant	12
2.5 Main Toxicological information on the type of refrigerant used	12
2.6 First aid measures	12
3. TECHNICAL CHARACTERISTICS	13
3.1 Unit description	13
3.2 Accessories description	15
3.3 Technical data	17
3.4 Operation limits.....	18
3.5 Correction tables.....	19
3.6 Sound data	19
4. INSTALLATION	20
4.1 General safety guidelines and use of symbols	20
4.2 Workers' health and safety	20
4.3 Personal protective equipment	20
4.4 Inspection	21
4.5 Transport and handling.....	21
4.6 Storage	22
4.7 Unpacking	23
4.8 Lifting and handling.....	23
4.9 Location and minimum technical clearances	24
4.10 Serial interface card RS485 (INSE)	25
4.11 Threaded Connection Diameters	25
4.12 Hydraulic connections.....	25
4.13 Chemical characteristics of the water	27
4.14 User circuit minimum water content.....	29
4.15 Filling the hydraulic circuit.....	29
4.16 Emptying the installation.....	29
4.17 Microchannel condensing coil.....	30
4.18 Wiring connections: Preliminary safety information	31
4.19 Electric data	32
5. UNIT START UP	33
5.1 Preliminary Checks	33
5.2 Operation of the refrigerant gas detection sensor	36
5.3 Safety valves	38
5.4 Position of the control panel	39
5.5 Description of the control panel	39
5.6 Remote keyboard connection	41
6. USE	42
6.1 Switch the unit on	42
6.2 Stop	43

6.3 How to change the set points	43
6.4 PROBES key	44
6.5 ALARM key	45
6.6 CIRC key	46
6.7 SERVICE key	48
6.8 Acoustic signal silencing	55
6.9 Emergency Stop	55
7. UNIT MAINTENANCE	56
7.1 General warnings	56
7.2 Access to the unit	57
7.3 Routine maintenance	57
7.4 Periodical checks	58
7.5 Refrigerant circuit repair	63
8. DECOMMISSIONING	64
8.1 Unit Isolation & drain down	64
8.2 Disposal, recovery and recycling	64
8.3 RAEE directive (only for EC countries)	64
9. DIAGNOSIS & TROUBLESHOOTING	65
9.1 Fault finding	65
10. DIMENSIONAL DRAWINGS	67

1. INTRODUCTION

1.1 Preliminary information

Reproduction, storage or transmission of any part of this publication in any form, without the prior written consent of the Company, is prohibited.

The unit to which these instructions refer, is designed to be used for the the purposes described and to be operated in accordance with these instructions.

The Company will not be liable for claims for damage caused to persons, animals, material goods or property caused by improper installation, adjustment and maintenance or improper use. Any use not specified in this manual is prohibited.

This document is intended to provide information only and does not form a contract with third parties.

The Company pursues a policy of constant improvement and development of its products and therefore reserves the right to change the specifications and the documentation at any time, without notice and without obligation to update existing equipment.

1.2 Aim and content of the manual

These instructions are intended to provide the information required for the selection, installation, use and maintenance of the unit.

They have been prepared in accordance with the European Union laws and with the technical standards in force at the date of issue of the instructions.

The instructions contain all the necessary information to prevent any reasonably foreseeable misuse.

1.3 How to store this manual

The manual must be kept in a suitable place with easy access for users and operators, protected from dust and damp.

The manual must always accompany the unit during the entire life cycle of the same and therefore must be transferred to any subsequent user.

1.4 Manual Update

It is recommended that the manual is updated to the latest revision available.

If updates are sent to the customer they must be added to this manual.

The latest information regarding the use of its products is available by contacting the Company.

1.5 How to use this manual



The manual is an integral part of the unit.

Users or operators must consult the manual before performing any operation and especially so when transporting, handling, installing, maintaining, or dismantling the unit in order to eliminate uncertainty and reduce risk.



In these instructions symbols have been used (described in the following paragraphs) to draw the attention of operators and users to the operations that have a higher risk and which must be performed safely.

1.6 Potential Risks

Whilst the unit has been designed to minimize any risk posed to the safety of people who will interact with it, it has not been technically possible to eliminate completely the causes of risk. It is therefore necessary to refer to the requirements and symbolism below:

LOCATION OF RISK	POTENTIAL RISK	METHOD OF INJURY	PRECAUTIONS
Thermal heat exchangers.	Small stab wounds.	Contact	Avoid any contact, use protective gloves.
Fan and fan grilles.	Cuts, eye damage, broken bones.	Insertion of sharp objects through the grid while the fans are operating.	Never put objects through the protection grilles.
Internal component: compressors and discharge pipes	Burns.	Contact	Avoid any contact, use protective gloves.
Internal component: electric cables and metallic parts	Electrocution, severe burns.	Defect in the supply cable insulation, live metallic parts.	Adequate protection of power cables, ensure correct earthing of all metal parts.
External to unit: unit enclosure	Poisoning, severe burns.	Fire due to short circuit or overheating of the supply cable external to unit.	Size cables and mains protection system in accordance with iee regulations.
Low pressure safety valve.	Poisoning, severe burns.	High evaporating pressure causing a refrigerant discharge during maintenance.	Carefully check the evaporating pressure during the maintenance operations.
High pressure safety valve.	Poisoning, severe burns, hearing loss.	Activation of the high pressure safety valve with the refrigerant circuit open.	If possible, do not open the refrigerant circuit valve; carefully check the condensing pressure; use all the personal protective equipment required by law.
Entire unit	External fire	Fire due to natural disasters or combustions of elements nearby unit	Provide the necessary fire-fighting equipment
Entire unit	Explosion, injuries, burns, poisoning, folgoramento for natural disasters or earthquake.	Breakages, failures due to natural disasters or earthquake	Plan the necessary precautions both electrical (suitable differential magneto and electrical protection of the supply lines; greatest care during the connections of the metal parts), and mechanical (special anchors or seismic vibrations to prevent breakages or accidental falls).

1.7 General Description of Symbols Used

Safety symbols combined in accordance with ISO 3864-2:



BANNED

A black symbol inside a red circle with a red diagonal indicates an action that should not be performed.



WARNING

A black graphic symbol added to a yellow triangle with black edges indicates danger.



ACTION REQUIRED

A white symbol inserted in a blue circle indicates an action that must be done to avoid a risk.

Safety symbols combined in accordance with ISO 3864-2:



The graphic symbol "warning" is qualified with additional safety information (text or other symbols).

1.8 Safety symbols used



GENERAL RISK

Observe all signs placed next to the pictogram. The failure to follow directions may create a risk situation that may be injurious to the user.



ELECTRICAL HAZARD

Observe all signs placed next to the pictogram. The symbol indicates components of the unit and actions described in this manual that could create an electrical hazard.



MOVING PARTS

The symbol indicates those moving parts of the unit that could create risk.



HOT SURFACES

The symbol indicates those components with high surface temperature that could create risks.



SHARP SURFACES

The symbol indicates components or parts that could cause stab wounds.



EARTH CONNECTION

The symbol identifies Earthing connection points in the unit.



READ AND UNDERSTAND THE INSTRUCTIONS

Read and understand the instructions of the machine before any operations.



RECOVER OR RECYCLE MATERIAL

1.9 Limitations and prohibited use

The machine is designed and built exclusively for the uses described in "Limitations of use" of the technical manual. Any other use is prohibited because it may pose a potential risk to the health of operators and users.





The unit is not suitable for operations in environments:

- excessively dusty or potentially explosive atmospheres;
- where there are vibrations;
- where there are electromagnetic fields;
- where there are aggressive atmospheres

1.10 Unit identification

Each unit has a rating plate that provides key information regarding the machine. The rating plate may differ from the one shown below as the example is for a standard unit without accessories. For all electrical information not provided on the label, refer to the wiring diagram. A facsimile of the label is shown below:

									
MODELLO MODEL MODELE MODEL		ANNO DI COSTRUZIONE / PED CATEGORIA MANUFACTURE YEAR / PED CATEGORY JAHR VON KONSTRUKT / PED KATEGORIE ANNÉE DE FABRICAT / CATEGORIE PED	2019 CAT						
MATRICOLA SERIAL NR N° DE SÉRIE STAMM NR		CORRENTE MAX. MAX CURRENT INPUT MAXIMALER STROM AMPÈRES MAXIMALE	A						
ALIMENTAZIONE ELET. SUPPLY VOLTAGE ALIMENTATION ELECT. SPANNUNG	400 V +/- 10% - 50 Hz +/- 2% - 3 PH - GND	ASSORBIMENTO ELETTRICO NOMINALE PUISSANCE ÉLECTRIQUE NOMINALE NOMINAL ABSORBED POWER NOMINALELEISTUNGS-AUFNAHME	kW						
GAS REFRIGERANTE REFRIGÉRANT RÉFRIGÉRANT KALTEMITTEL	R290 / 3,3	CORRENTE CORTO CIRCUITO SHORT CIRCUIT CURRENT COURANT COURT-CIRCUIT STROM KURZSCHLUSS	kA 10						
CARICA REFRIGERANTE REFRIGÉRANT CHARGE KALTEMITTEL CHARGE FRIGORIGÈNE	<table border="1"> <tr> <td>C1</td> <td>C2</td> <td>kg.</td> </tr> <tr> <td>C1</td> <td>C2</td> <td>CO2 Ton</td> </tr> </table>	C1	C2	kg.	C1	C2	CO2 Ton	PESO OPERATIVO OPERATING WEIGHT POIDS OPERATION. ARBEITSGEWICHT	kg.
C1	C2	kg.							
C1	C2	CO2 Ton							
LATO BASSA PRESSIONE / LOW PRESSURE SIDE CIRCUIT BASSE PRESSION / NIEDERDRÜCKSEITE		LATO ALTA PRESSIONE / HIGH PRESSURE SIDE CIRCUIT HAUTE PRESSION / HOCHDRÜCKSEITE							
PRESSIONE DI PROGETTO DESIGN PRESSURE PRESSION DE PROJET DRUCK DES PROJEKTES		--	Bar						
TEMP. MIN PROGETTO MINI DESIGN TEMPERATURE KLEINSTE TEMP. DES PROJEKTES TEMP. MOINORE DE PROJET		- 30	°C						
MAX TEMPERATURA PROGETTO MAX DESIGN TEMPERATURE MAXIMALE TEMP. DES PROJEKTES MAXIMUM TEMP DE PROJET		+ 54	°C						
		PRESSIONE DI PROGETTO PS DESIGN PRESSURE PS PRESSION DE PROJET PS DRUCK DES PROJEKTES PS	-- Bar						
		TEMP. MIN PROGETTO MINI DESIGN TEMPERATURE KLEINSTE TEMP. DES PROJEKTES TEMP. MOINORE DE PROJET	- 10 °C						
		MAX TEMPERATURA PROGETTO MAX DESIGN TEMPERATURE MAXIMALE TEMP. DES PROJEKTES MAXIMUM TEMP DE PROJET	+110 GAS °C +65 LIQU						
		TARATURA ORGANO SICUREZZA SETTING OF SAFETY DEVICE MISE AU POINT DISPOSITIF DE SECURITÉ EINSTELLWERT ICHERHEITSELEMENT	-- Bar						



The product label should never be removed from the unit.

2. SAFETY

2.2 Warning on potentially dangerous toxic substances

2.2.1 Identification of the used fluid: R290 (Propane)



WARNING!

The refrigerante R290 (PROPANE) is flammable and it must be handled only by competent and responsible operators, under the conditions specified in the safety regulations in force.



DO NOT SMOKE

NO NAKED FLAMES

The refrigerant used is Propane (R290). In compliance with 2014/68/EU directive (hereafter: PED), this substance is considered a gas (PED, art. 13) of Group 1 which contains the dangerous fluids (extremely flammable). According EN 378-1, att. F, Propane is classified as a Group 3 substance (low toxicity, high flammability).

Safety information of this refrigerant are listed in the following table

Nome chimico	Propano
Designazione (ISO 817)	R290
Formula chimica	C_3H_8
Gruppo di sicurezza (EN378-1)	A3
Classificazione PED	Group 1 Gas
Limite inferiore di infiammabilità (LFL)	0,038 kg/m ³ – 2,1% m ³ /m ³
Limite superiore di infiammabilità (UFL)	0,177 kg/m ³ – 9,8% m ³ /m ³
Densità del vapore (a 25°C, 101,3 kPa)	1,832 kg/m ³
Densità relativa	1,56
Massa molecolare	44 kg/kmol
Punto di ebollizione normale	-42°C
Temperatura di autoaccensione	470°C
Temperatura di infiammabilità	-104°C
Potenziale di riduzione dell'ozono (ODP)	0
Potenziale di riscaldamento globale (GWP - orizzonte temporale di 100 anni)	3 (CO ₂ = 1)

Note that Propane has an higher density then the air one, therefore in case of leaks, it will tend to flow down

CHEMICAL COMPOSITION OF PROPAN USED AS A REFRIGERANT:

Refrigerant content ≥ 99,5% by mass
Organic impurities ≤ 0,5% by mass

1,3 Butadiene (for each single unsaturated multiple hydrocarbon)	≤ 5 ppm in mass
Normal Hexane	≤ 50 ppm in mass
Benzene (for each aromatic mixture)	≤ 1 ppm in mass
Sulfur	≤ 2 ppm in mass
Non-condensable gases	≤ 1,5% in volume della fase vapore
Water	≤ 25 ppm in mass
Acid content	≤ 0,02 mg KOH/g per la neutralizzazione
Evaporation residue	≤ 50 ppm in mass
Particles / solids	Nessuno (ispezione visiva)
Evaporating temperature glide	≤ 0,5 K
Practical limit (EN378-1, all.F)	0,008 kg/m ³
Acute Toxicity Exposure Limit (ATEL) / O2 Deprivation Limit	0,09 kg/m ³

Propane highlights compatibility problems with some rubber or plastic types, particularly if clorurated. Tests on critical materials will be required.

2.1.2 Identification of the Type of Oil Used.

The lubricant used is polyester oil. Please refer to the information provided on the compressor data plate to verify the type of oil used.

Main Ecological Information Regarding the Types of refrigerants Fluids used.



ENVIRONMENTAL PROTECTION : Read the ecological information and the following instructions carefully.

2.1.3 Persistence and degradation

The refrigerants used decompose in the lower atmosphere (troposphere) relatively quickly. The decomposed products are highly dispersible and therefore have a very low concentration. They do not influence the photochemical smog which is not among the VOC volatile organic compounds (as stipulated in the guidelines to the UNECE). The used constituent refrigerants do not damage the ozone layer. These substances are regulated under the Montreal Protocol (revised 1992) and regulations EC no. 2037/200 of 29 June 2000.

2.1.4 Effects of discharges

Discharges into the atmosphere of this product does not cause a long-term contamination.

2.1.5 Exposure controls and personal protection

Wear protective clothing and gloves, protect your eyes and face

2.1.6 Professional exposure limits

Limit values TLV-TWA: 2500 ppm

2.2 Refrigerant handling



Users and maintenance personnel must be adequately informed about the possible risks of handling potentially toxic substances. Failure to follow such instructions can cause damage to personnel or to the unit.

2.3 Prevent inhalation of high vapor concentration

Atmospheric concentrations of refrigerant must be minimized and kept to a level that is below the occupational exposure limit. Vapor is heavier than air and can form dangerous concentrations near the ground where the ventilation rate is lower. Always ensure adequate ventilation. Avoid contact with open flames and hot surfaces as this can cause toxic and irritating decomposition products to form. Avoid contact between liquid refrigerant and the eyes or skin.

2.4 Procedures to be adopted in the event of accidental release of refrigerant

Ensure suitable personal protection (especially respiratory protection) during cleaning operations.

If deemed safe, isolate the source of the leak. If the leakage is small and if adequate ventilation is provided, allow the refrigerant to evaporate. If the loss is substantial ensure that measures are taken to adequately ventilate the area.

Contain spilled material with sand, earth or other suitable absorbent material.

Do not allow the refrigerant to enter drains, sewers or basements, as pockets of vapor can form.

2.5 Main Toxicological Information Regarding the Type of refrigerant used

2.5.1 Inhalation

A high atmospheric concentration can cause anaesthetic effects with possible loss of consciousness. Prolonged exposure may lead to irregular heartbeat and cause sudden death. Higher concentrations may cause asphyxia due to the reduced oxygen content in the atmosphere.

2.5.2 Contact with skin

Splashes of nebulous liquid can produce frostbite. Probably not hazardous if absorbed through the skin. Repeated or prolonged contact may remove the skin's natural oils, with consequent dryness, cracking and dermatitis.

2.5.3 Contact with eyes

Splashes of liquid may cause frostbite.

2.5.4 Ingestion

While highly improbable, may produce frostbite.

2.6 First Aid Measures



Adhere scrupulously to the warnings and first aid procedures indicated in the REFRIGERANT AND LUBRICANT OIL SAFETY DATA SHEET downloadable via the following QR codes.



Always refer to the compressor nameplate to identify the type of oil used in the refrigeration circuit.



REFRIGERANT: R290 Safety data sheet
OIL: 150PAG

3. TECHNICAL CHARACTERISTICS

3.1 Unit description

The air-cooled chillers of this serie are suitable for outdoor installation and are particularly suitable for cooling liquid solutions, used for industrial applications or air conditioning systems, in which it is necessary to ensure excellent performance and very low environmental impact.

The machines are designed as outdoor units in compliance with European standards EN378 and its updates and are able to meet the seasonal efficiency requirements established by Regulation (EU) 2016/2281-LOT21.

The units in the series are equipped with two semi-hermetic screw compressors, one of which provided with continuous control of the cooling capacity thanks to a dedicated inverter. Each compressor operates on a single, completely independent circuit, thus ensuring maximum reliability.

The micro-channel type condensing coils are made entirely of aluminium alloy. Compared to traditional copper-aluminum coils, the geometry of the microchannel offers less resistance to the passage of air. This allows to optimize the work done by the fan section and consequently reduce the overall dimensions with the same performance.

The micro-channel technology also allows a significant reduction in the weight of the condensing section and the overall refrigerant charge.

The transversal "V" disposition of the condensing coils makes the units in this series perfectly modular, also guaranteeing maximum accessibility to the technical compartment both for the control operations that are necessary during normal operation of the unit and during all maintenance operations.

Thanks to the wide range of accessories available, these units are particularly versatile and can be easily adapted to the various types of systems in which chilled water production is required.

The units are completely assembled and tested in the factory, supplied with refrigerant charge and no freezing oil. Therefore, once on site, they only need to be positioned and connected to the electrical and hydraulic network.

3.1.1 Frame

Strong and compact structure, made of base and frame with high-thickness galvanized steel elements assembled with stainless steel rivets; All galvanized steel surfaces externally positioned are superficially coated by an oven powder-painting with color RAL7035. The technical section which contains compressors and the other cooling circuit elements is closed in a sound-proofed and insulated cabinet.

3.1.2 Compressors

Semi-hermetic screw compressors, optimized for operation with hydrocarbons and manufactured in accordance with current safety regulations. The compressors, one for each circuit, are with motor thermal protection, rotation direction control, crankcase heater, liquid injection, suction and discharge shut-off valves, compressor overload relays and vibration kit. Lubrication is of the forced type without a pump and to avoid excessive oil migration to the cooling circuit, there is an oil separator incorporated in the delivery. The electric motor is equipped with an automatic partial load starting system and mechanical interlock of the starting contactors, to avoid accidental short circuits.

3.1.3 User side exchanger

Each unit, depending on the cooling capacity required, is equipped with one or two stainless steel plates type bi circuits evaporators, thermally insulated using a flexible closed cells mattress of high thickness. The evaporator is equipped with a safety differential pressure switch on water side, which does not allow the unit operation in case of water flow lack or reduction.

3.1.4 Aeraulic Coils

The external exchanger coils are made of microchannel aluminium extruded pipes and brazed aluminium fins. Thanks to the reduced whole volume and the high external surfaces, these coils allow a great reduction of refrigerant charge and high heat exchange capacity.

3.1.5 Axial Fans

With 6-poles electrical motor with external rotor directly coupled to the impeller and driven by a V/F inverter system which controls the condensation temperature. Aluminum blades with wings profile are suitably designed to avoid any turbulence in the air detachment zone, granting in this way the max efficiency with the minimum noise level. The fan is equipped with galvanized steel protection grid painted after the construction. The fan motors are of totally closed type and have got a protection factor IP54 and protection winding-flooded thermostat.

3.1.6 Cooling circuit

Independent cooling circuits each provided with a shut-off valve for refrigerant charge, antifreeze probe, sight glass, dehydrating filter with wide filtering surface, high pressure side safety valve equipped with connector to the discharge refrigerant conveying piping, built-in check valve on the discharge side of the compressor, electronic thermostatic valve, settable pressure switches and high/low pressure gauges. All the components the cooling circuit is made of are suitable to work with hydrocarbons and with Propane specifically.

3.1.7 Electrical board

The electrical panel is separated from the technical section and is realized in order to avoid the refrigerant entry in case of leak. The inverter compartment is separated as well and equipped with self-ventilation system. The unit is planned in order to activate the actuators block in case of anomalies.

The electrical panel, in compliance with European standards in force, is built inside of a metal container with a protection factor making it suitable for an external installation. Its main features are:

- Three-phase power supply 400V/3ph/50Hz +N in all the units (special requests excluded);
- Control circuit 24Vac with insulation transformer;
- Auxiliary circuit 230V with insulation transformer;
- Compressors protection with magneto thermal switch and fuses and also with thermal module (Kriwan);
- Mechanical main switch with door-locker;
- Signal and control Free-contacts terminal board;

Inside the a.m. electrical cabinet, closed by an access panel equipped with main switch, are installed the following main components:

- Contactors;
- Transformers;
- Numerated conductors;
- Low tension auxiliary circuits;
- Terminal boards;
- Management and control electronic boards.

All the units are subject to the safety cycle with protection circuit continuities tests, insulating heater and tension test (dielectric strength). The group is realized through the management program recorded in the electronic microprocessor.

The microprocessor is made up of:

- A Control electronic board with the terminal boards for the functional parameters transmission and the activation of the control devices;
- User interface card with program keys and alphanumeric display showing the operating status, realizing among the others, the following functions:
 - Unit ON/OFF from keyboard or remotely;
 - Alarm and alert status management;
 - Compressors operating status.

The User interface display of the microprocessor also allows to see the following parameters:

- Set regulation parameters values;
- Functional variables values;
- Digital and analogical input /output status;
- Unit operation status;
- Alarm and alert warning;
- BMS systems interfacing possibility.

3.1.8 Microprocessor

Electronic Microprocessor for unit management installed inside the electrical cabinet, with double evaporator in/out control of the chilled water temperature, as well as control of working parameters and equalization of compressors working hours, failures auto-detection system, alarm log, start and set point timeslot programming, possibility of remote management and supervision by enabling standard communication protocols management, complete with compressors hour counter.

3.1.9 Refrigerant gas detection sensor

As standard, the unit is equipped with a sensor located inside the compressor compartment, which continuously analyses the surrounding air and generates an alarm in the system if a refrigerant concentration above the threshold values is detected (due to a leak). The sensor is electrically connected to a control unit located inside the electrical panel, which coordinates its operational functions.

3.2 Accessories description

- A+V** **Amperometer and voltmeter:** Electrical devices used to measure the electrical current absorbed and the electrical supply voltage of the unit.
- AXT** **Axial fan diffuser :** It allow a reduction of energetic consumption and of noise pressure thanks to the optimization of the air flow.
- CS** **Compressors inrush counter:** Electromechanical device positioned inside the electrical board, recording the total inrush starts of compressors.
- EC** **Axial fans with electronic commutated motor:** with external rotor directly coupled to a three-phase electronically commutated motor (EC) they have the possibility of a continuous regulation of the speed by means of a 0-10V signal completely managed by the microprocessor. Aluminum blades with wings profile are suitably designed to avoid any turbulence in the air detachment zone, granting in this way the max efficiency with the minimum noise level. The fan is equipped with galvanized steel protection grid painted after the construction. Thanks to a more accurate adjustment of air flow, they allow operation of the unit with external temperature down to -20°C.
- ECP** **Anticorrosive electro coating protection of condensing coils:** Treatment of the coils composed by electro deposition process of epoxy paint particle forming an uniform and continuous film over the whole surface of exchanger, creating a flexible and smooth coating that is particularly resistant to corrosive agents. This type of treatment is indicated in case of installation in high contaminants concentration industrial environments (>100ppm), high atmospheric pollution urban areas (>125 ug/m³) or near costal areas.
- GP** **Condensing coil protection grid:** Metal grid to protect against accidental impacts. (Alternative to GP1).
- GP1** **Protection grid:** Painted metal grid to protect the technical compartment (alternative to GP).
- IH** **RS 485 Serial interface:** Electronic card to be connected to the microprocessor to allow connection of the units to supervision systems, for a remote control and monitoring of the unit. (Alternative to IH BAC).
- IH-BAC** **BACNET Protocol Serial Interface:** Gateway to be connected to the microprocessor to allow the connection of the unit to external supervision system with BACNET Protocol in order to fully and remotely assistance (alternative to IH).
- KLD** **Display interface kit for refrigerant leak sensor - maintenance free:** Portable interface kit with graphic display that can be connected to the refrigerant leak sensor control board via a 4-pole cable (supplied in the kit). It allows you to carry out the operations of checking and setting the operating parameters of the sensor during periodic inspection and service.
- MP ADV** **Enhanced microprocessor board**
- MSC** **Advanced Cascade system**
- MV** **Buffer tank module:** Of suitable capacity complete with expansion vessel, safety valve, water gauge, water charge and discharge valves, air purging valves, check valves for filter service operations.
- P1** **Pump group:** Chilled water pump group made of a single pump, expansion vessel, safety valve water gauge, water charge and discharge valves, air purging valves, electric control of the pump. The pump is of enbloc 2-pole type.
- P1H** **Higher available pressure pump group:** Chilled water pump group made of a single pump, expansion vessel, safety valve water gauge, water charge and discharge valves, air purging valves, electric control of the pump. The pump is of enbloc 2-pole type.
- P2** **Double pump group (only one working):** Chilled water pump group made by two pumps in parallel, expansion vessel, safety valve, water gauge, water charge and discharge valves, air purging valves, water shut-off valve on suction and check valve on discharge for each single pump, electric control of the pump. The pump is of enbloc 2-pole type.
- P2H** **Higher available pressure double pump group (only one working):** Chilled water pump group made by two higher available pressure pumps in parallel, expansion vessel, safety valve, water gauge, water charge and discharge valves, air purging valves, water shut-off valve on suction and check valve on discharge for each single pump, electric control of the pump. The pump is of enbloc 2-pole type.

- PA **Rubber-type vibration dampers:** Vibration bell type dampers for insulating the unit from the support base (supplied in kit), composed of a bell base in galvanized steel and rubber compound.
- PM **Spring-type vibration dampers:** Spring-type vibration dampers support, for insulating the unit (supplied in kit), mainly indicated for installation in difficult and aggressive environments. Made of two steel plates containing a suitable quantity of harmonic steel springs.
- PQ **Remote display:** Remote interface displaying temperature values detected by probes, alarm digital inputs, outputs, remote ON/OFF of the unit. It also gives the possibility to change and program parameters and report/display alarms.
- RA **Anti-freeze heater on evaporator:** Electrical heater installed on the evaporator, in order to prevent freezing and provided with thermostat.
- RL **Compressor overload relays:** Electromechanical protection devices against compressors overload.
- VSP1 **Inverter for pump:** This option provides the installation of an inverter combined to user pump/s module.
- VSP1H **Inverter for high-pressure pump:** This option provides the installation of an inverter combined to user high-pressure pumps module.
- VSP2 **Inverter for pumps (only one working):** This option provides the installation of an inverter combined to user pumps module.
- VSP2H **Inverter for high-pressure pumps (only one working):** This option provides the installation of an inverter combined to user high-pressure pumps module.

3.3 Technical data

RAH MC VS U Kp		402	502	602	652	752
Nominal cooling capacity	kW	397,2	524,8	631,3	693,2	788,7
Total input power	kW	137,9	182,0	216,4	231,3	263,2
Total nominal current	A	239,0	308,7	369,0	395,5	453,2
EER	-	2,88	2,88	2,92	3,00	3,00
SEPR	-	5,10	5,53	5,55	5,52	5,55
Refrigerant circuits	n°	2	2	2	2	2
Compressors	n°	2	2	2	2	2
Refrigerant data R290						
Refrigerant charge	kg	27	30	36	42	44
Global warming potential (GWP)		0,02	0,02	0,02	0,02	0,02
Equivalent CO ₂ charge	kg	0,54	0,60	0,72	0,84	0,88
Axial fans ⁽¹⁾						
Number	n°	8	8	10	12	12
Total air flow	m ³ /h	165600	165600	207000	248400	248400
Total fan power input	kW	15,5	15,5	19,4	23,3	23,3
Evaporator ⁽²⁾						
Number	n°	1	2	2	2	2
Water flow	m ³ /h	68,3	90,3	108,6	119,2	135,6
Pressure drop	kPa	32	32	30	35	37
Water connections diameter		2x5" VIC	2x5" VIC	2x5" VIC	2x6" VIC	2x6" VIC
Weights						
Transport weight	kg	3602	3832	5002	5380	5532
Operating weight	kg	3648	3898	5078	5456	5626
Dimensions						
Length	mm	5860	5860	7200	8540	8540
Depth	mm	2260	2260	2260	2260	2260
Height	mm	2470	2470	2470	2470	2470
Sound data						
Sound pressure level ⁽³⁾	dB(A)	92,4	92,8	94,2	95,5	96,0
Sound power level ⁽⁴⁾	dB(A)	60,0	60,4	61,5	62,7	63,2
Power supply						
Voltage/Phase/Frequency	V/ph/Hz	400/3/50	400/3/50	400/3/50	400/3/50	400/3/50

Performances are referred to the following conditions:

(1) Air temperature 35°C

(2) Fluid: water - in/out temperature: 12/7°C

(3) Sound power level in accordance with ISO 3744.

(4) Sound pressure level at 10 mt from the unit in free field conditions in accordance with ISO 3744.



The refrigerant data may change without notice. It is therefore necessary to refer always to the silver label placed on the unit.

3.4 Operational limits

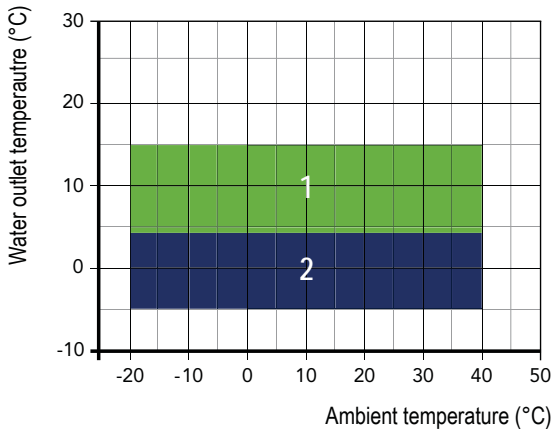

- 1 Standard cooling mode with fan speed control
- 2 Standard cooling mode with fan speed control and glycol

3.4.1 User heat exchanger water flow rate

The nominal water flow rate provided, relates to a ΔT of 5K. The maximum flow rate allowed is one that provides a ΔT of 3K. Higher values may cause too high a pressure drop. The minimum water flow rate allowed is that which results in a ΔT of 7K. Insufficient flow will result in evaporating temperatures that are too low leading to the operation of safety devices that will prevent unit operation.



Units are designed and manufactured to European safety and technical standards. The units have been designed exclusively for cooling and DHW production. The units must be used for this specific purpose only. The Company will not be liable for claims for damage caused to persons, animals or material goods or property caused by improper installation, adjustment and maintenance or improper use. Any use not specified in this manual is prohibited.



In case of operations outside of these values, please contact the company.



If the unit is installed in particularly windy areas, it will be necessary to provide some windbreaker barriers to avoid any malfunction. We suggest to install the barriers only if the wind exceeds 2,5m/s.



The units, in their standard configuration, are not suitable for installation in saline environments.

3.5 Correction tables

3.5.1 Operation with glycol

Glycol percentage	Freezing point (°C)	CCF	IPCF	WFCF	PDCF
10	-3.2	0.985	1	1.02	1.08
20	-7.8	0.98	0.99	1.05	1.12
30	-14.1	0.97	0.98	1.09	1.22
40	-22.3	0.965	0.97	1.14	1.25
50	-33.8	0.955	0.965	1.2	1.33

CCF: Capacity correction factor

IPCF: Input power correction factor

WFCF: Water flow correction factor

PDCF: Pressure drops correction factor

The water flow rate and pressure drop correction factors are to be applied directly to the values given for operation without glycol. The water flow rate correction factor is calculated in order to maintain the same temperature difference as that which would be obtained without glycol. The pressure drop correction factor takes into account the different flow rate obtained from the application of the flow rate correction factor.

3.5.2 Correction tables different Δt

Water temperature diff.(°C)	3	5	8
CCCP	0.99	1	1.02
IPCF	0.99	1	1.01

CCCP = Cooling capacity correction factor

IPCF = Input power correction factor

3.5.3 Correction tables different Fouling factors

Fouling factor	0.00005	0.0001	0.0002
CCCP	1	0.98	0.94
IPCF	1	0.98	0.95

CCCP = Cooling capacity correction factor

IPCF = Input power correction factor

3.6 Sound data

RAH MC VS U KP											
Mod.	Octave bands (Hz)								Lw dB(A)	Lp1 dB(A)	Lp10 dB(A)
	63 dB(A)	125 dB(A)	250 dB(A)	500 dB(A)	1K dB(A)	2K dB(A)	4K dB(A)	8K dB(A)			
402	84,6	80,9	78,3	84,7	87,8	84,6	77,7	73,1	92,4	71,7	60,0
502	84,6	80,9	78,3	84,7	88,7	85,1	77,7	73,1	92,8	72,1	60,4
602	85,6	81,9	79,3	85,9	90,3	86,3	78,7	74,1	94,2	72,9	61,5
652	86,4	82,7	80,1	89,0	90,4	89,3	79,5	74,9	95,5	73,8	62,7
752	86,4	82,7	80,1	90,2	90,8	89,4	79,5	74,9	96,0	74,3	63,2

Lw: Sound power level according to ISO 3744.

Lp1: Sound pressure level measured at 1 mt from the unit in free field conditions direction factor Q=2 according to ISO 3744.

Lp10: Sound pressure level measured at 10 mt from the unit in free field conditions direction factor Q=2 according to ISO 3744.

4. INSTALLATION

4.1 General safety guidelines and use of symbols



Before undertaking any task the operator must be fully trained in the operation of the machines to be used and their controls. They must also have read and be fully conversant with all operating instructions.



All maintenance must be performed by TRAINED personnel and be in accordance with all national and local regulations.



If the unit contains flammable refrigerant gas, people qualified to carry out any operation on the machine must be properly trained.



The installation and maintenance of the unit must comply with the local regulations in force at the time of the installation.



Avoid contact and do not insert any objects into moving parts.

4.2 Health and safety Considerations



The workplace must be kept clean, tidy and free from objects that may prevent free movement. Appropriate lighting of the work place shall be provided to allow the operator to perform the required operations safely. Poor or too strong lighting can cause risks.



Ensure that work places are always adequately ventilated and that respirators are working, in good condition and comply fully with the requirements of the current regulations.

4.3 Personal protective equipment



When operating and maintaining the unit, use the following personal protective equipment listed below as required by law.



Protective footwear.



Eye protection.



Protective gloves.



Respiratory protection.



Hearing protection.

4.4 Inspection

When installing or servicing the unit, it is necessary to strictly follow the rules reported on this manual, to conform to all the specifications of the labels on the unit, and to take any possible precautions of the case. Not observing the rules reported on this manual can create dangerous situations. After receiving the unit, immediately check its integrity. The unit left the factory in perfect conditions; any eventual damage must be questioned to the carrier and recorded on the Delivery Note before it is signed. The company must be informed, within 8 days, of the extent of the damage. The Customer should prepare a written statement of any severe damage.

Before accepting the unit check:

- The unit did not suffer any damage during transport;
- The delivered goods are conforming to what shown in the delivery note.

In Case of Damage

- List the damage on the delivery note
- Inform the Company of the extent of the damage within 8 days of receipt of the goods. After this time any claim will not be considered.
- A full written report is required for cases of severe damage.

4.5 Transport and handling

In compliance with the EN 378-1, the unit can be identified as an indirect closed system, The refrigerant charge and type are indicated on the unit identification tag.

The unit handling must be done by skilled personnel only, with suitable equipment to the unit weight and dimensions. During the handling operations, keep the unit in vertical position (i.e. with the basement parallel to the ground)



The transport company is always responsible for any possible damage during the transport of the goods. Before installing the unit and preparing it for the commissioning, accurately sight inspect the unit to verify the packaging integrity or that the unit has no visible damage, and oil or refrigerant leakage. Also verify that the unit complies what required in phase of order.



Any possible damage or claim must be communicated to the Manufacturer or to the carrier by means of registered mail within 8 days from goods receipt.



If one or more components are damaged, do not start the unit, and immediately inform the manufacturer, in order to agree any intervention on the unit.



It is suggested to unpack the unit at effective unit installation place. The internal handling must be done with care, avoiding using the equipment components as holds. Avoid any damage during the unit handling.



The hydraulic circuit must be fully empty before anyhow move the unit.



The units lifting must be vertical, preferably done by means of a forklift. Use a distribution beam if straps or ropes are used for the harness, carefully checking that no pressure is done on the higher edges of the unit or of the packaging.

PAY ATTENTION:

The refrigerant contained in the unit is flammable.

The unit can be installed outside only, away from any kind of possible ignition source and from direct sunlight.

Max external air temperature: +40°C (in operation)



4.6 Storage

If it is necessary to store the unit, leave it packed in a closed place. If for any reason the machine has already been unpacked, follow these instructions to prevent damage, corrosion and/or deterioration:

- Make sure that all openings are properly closed or sealed;
- Never use steam or other cleaning agents to clean the unit that could damage it;
- Remove any keys needed to access the control panel and entrust them to the site manager.



The unit can be stored at temperatures between -20°C and 65°C.



Exceeding the maximum storage temperature entails the risk of leakage of the refrigerant through the safety valve and the consequent formation of a potentially explosive mixture.



During the period of non-use, in order to prevent corrosive phenomena, deposits or breakages due to the formation of ice, it is of fundamental importance that the heat exchangers, on the utility side, are totally empty or completely full of adequately glycolated water.

4.7 Unpacking



Packaging could be dangerous for the operators.

It is advisable to leave packaged units during handling and remove it before the installation. The packaging must be removed carefully to prevent any possible damage to the machine. The materials constituting the packaging may be different in nature (wood, cardboard, nylon, etc.).



The packaging materials should be separated and sent for disposal or possible recycling to specialist waste companies.

4.8 Lifting and handling

When unloading the unit, it is strongly recommended that sudden movements are avoided in order to protect the refrigerant circuit, copper tubes or any other unit component. Units can be lifted by using a forklift or, alternatively, using belts. Take care that the method of lifting does not damage the side panels or the cover. It is important to keep the unit horizontal at all time to avoid damage to the internal components. Handling must be carried out by skilled personnel with appropriate equipment for the weight and size of the model. The total weight of the unit must be checked before lifting.

It is required to lift the unit using all the lifting points provided and with the appropriate distance bar (not included). When the unit is unloaded and positioned, it is necessary to take the maximum care to avoid rough or heavy movements in order to protect the internal components.

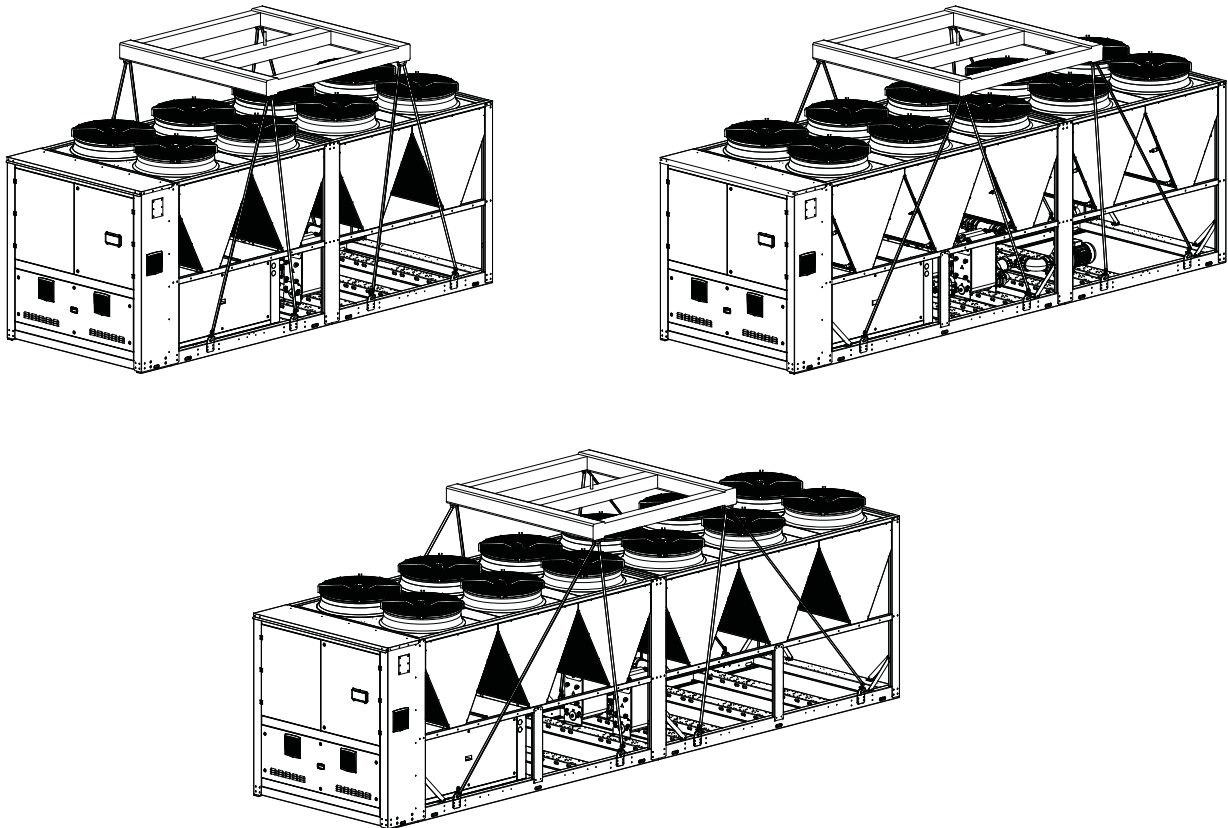

The Source heat exchangers fins are sharp. Use protection gloves.

4.9 Location and minimum technical clearances

All units are designed for external installation : any overhang above the unit and location near trees, if they partially cover the unit, must be avoided in order to prevent air by-pass. It is advisable to create a proper mounting plinth, with a size similar to the unit foot-print. Unit vibration level is very low: it is advisable however, to install vibration dampers (spring or rubber) between the plinth and the unit base-frame to keep vibrations at a very low level. It is vital to ensure adequate air volume to the source fan. Re-circulation of discharge air must be avoided; failure to observe this point will result in poor performance or activation of safety controls. For these reasons it is necessary to observe the following clearances.

For safety reasons, inside this area, no further devices, systems or ignition sources must be installed. Inside this area, the surfaces must not reach a temperature higher than 100 K from the auto-ignition temperature of the used refrigerant.

If the unit is installed in a zone with Class A (Generic) or Class B (with Supervision) presences, in compliance with the EN 378-1, par. 4.1, only the authorized person must be allowed near the unit, inside the spaces to be left free.

The unit must be positioned as much far as possible, and anyway at 3 m minimum, from drainage or electrical systems, in order to avoid the spread of potentially explosive atmospheres, in case of refrigerant leakages.

In any case, all the systems nearby the unit, must be filled with sand or equipped with siphon. The underground pipelines must be positioned at 0.80 m under the ground level at least.

The systems must be inspected every 6 months at least, in order to verify that the taken precaution to avoid the propagation of explosive atmospheres are efficient.

The group must be installed so that any possible refrigerant leakage cannot penetrate inside any building or closed ambient.



The unit has to be installed such that maintenance and repair is possible. The warranty does not cover costs for the provision of lifting apparatus, platforms or other lifting systems required to perform repairs during warranty period.



The installation site should be chosen in accordance with EN 378-1 and 378-3 standards. When choosing the installation site, all risks caused by accidental refrigerant leakage should be taken into consideration.

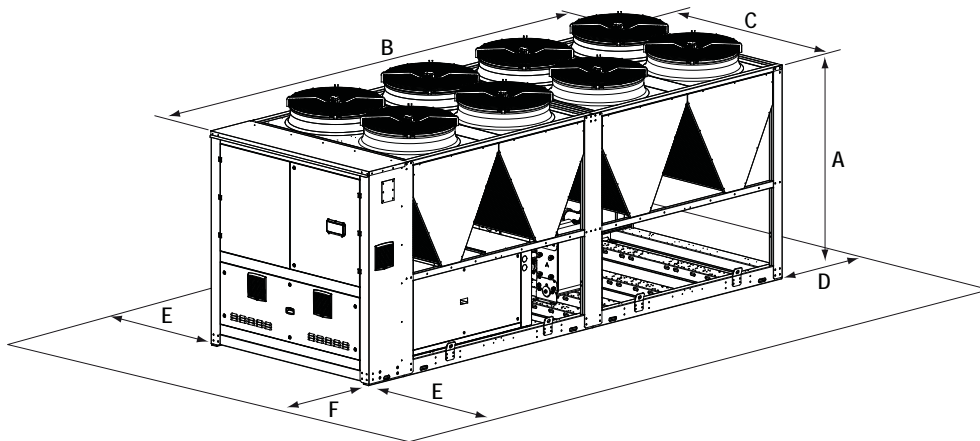

RAH MC VS U KP	A	B	C	D	E	F
402	2470	5860	2260	2000	2000	2000
502	2470	5860	2260	2000	2000	2000
602	2470	7200	2260	2000	2000	2000
652	2470	8540	2260	2000	2000	2000
752	2470	8540	2260	2000	2000	2000

4.10 Serial interface card RS485 (IH) (Optional)

Supervision system interface (MODBUS RS485 available only)

This system allows you to remotely monitor all parameters of the unit and change their values.

It is necessary to respect the polarity of the wiring as shown in the diagram. Any reversal of polarity will result in the non-functioning unit. The supervision connectivity cable must be telephone one type 2x0, 25 mm².

The unit is configured at the factory with serial address 1. In case of using the MODBUS system, you can request the list of variables by contacting the assistance.

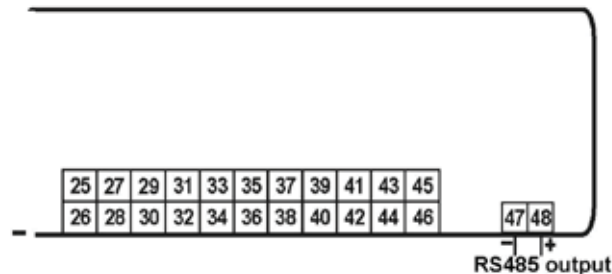

4.11 Threaded Connection Diameters

RAH MC VS U Kp		
402	108 mm	Filter cartridge
502	108 mm	Filter cartridge
602	108 mm	Filter cartridge
652	108 mm	Filter cartridge
752	108 mm	Filter cartridge

4.12 Hydraulic connections

The water pipe-work must be installed in accordance with national and local regulation and can be made from copper, steel, galvanized steel or PVC. The Pipework must be designed to cater for the nominal water flow and the hydraulic pressure drops of the system, a maximum pressure drop of 300 Pa/m run being typical. All pipes must be insulated with closed-cell material of adequate thickness. The hydraulic piping should includes:

- Pockets for temperature sensor to measure the temperature in the system.
- Shut-off manual valves to isolate the unit from the hydraulic circuit.
- Metallic filters to be mounted on the inlet pipe with a mesh not larger than 1 mm.
- Vent valves, expansion tank with water filling, discharge valve.



The hydraulic connection diameters are specified in the "Technical Data" table.



System return water must be fitted to the connection labelled: "USER WATER IN" as incorrect connection can damage the heat exchanger by freezing.



It is compulsory to install on the USER WATER IN connection, a water strainer with a mesh not larger than 1 mm. Fitting this filter is **COMPULSORY** and the warranty will be invalidated if it is removed. The filter must be kept clean and checked periodically.

The connection of the unit to the hydraulic circuit must be carried out by an experienced and qualified technician in accordance with the local regulations in force.



The connection of the unit to the system must be carried out in such a way that the fluid to be cooled circulates in the evaporator in the correct direction. To this purpose, the pipes must be connected in compliance with the instructions given in the connection on the unit.

To connect the pipes to the evaporator, take care of the following advises:

- Connect the pipes as shown in picture

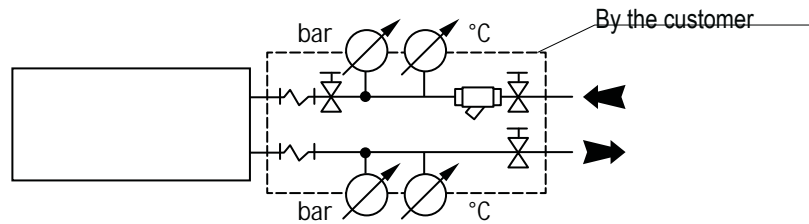

- To avoid any vibration transmission and permit the thermal expansions, anti-vibration fittings must be installed on the pipes. ;
- To avoid the inlet of foreign bodies and particles, you need to install, on unit inlet, a cleanable mechanic filter, with mesh dimension not larger than 1mm and with suitable nominal diameter, to reduce pressure drops;
- The installation of shut-off valve up and down stream of the filter is recommended, in order to make the cleaning operation simpler and quicker;
- The installation of thermometers and gauges near the inlet and outlet connection of the device, make the check of the unit operation easier;
- The chilled water system must be coated with close-cells anti-condensation material, with thermal insulation characteristics, vapor impermeability and with suitable thickness for the worst foreseeable conditions, in operation and stand-by mode;
- Use the pre-arranged connection shown in the attached dimensional drawing to connect the unit to the hydraulic system;
- Once the circuit is done and the unit installed, seal test of the whole system must be done, in order to find out any possible leakage and repair it, before the circuit filling and commissioning.



After the seal test, if the start-up of the system is planned after a long period of stop or if the ambient temperature can go down till values near to 0°C or lower, you need to drain the water from the circuit or enter a suitable percentage of glycol.



If the pump group for the fluid circulation inside the evaporator is not supplied with the unit, be sure that the compressors start only after that the pump group is on.



In case of breaking of the user side exchanger, the refrigerant can enter the water circuit. Position then the vent valves of the system in airy zone and far from manholes where the refrigerant could be concentrated, creating potentially explosive atmospheres. If not possible, the closed ambient where these vent valves are present, must be arranged with the precautions stated in the EN-378.



All units are factory supplied with a flow switch or differential pressure switch. Whether this device is altered, removed, or the water filter omitted on the unit, the warranty will be invalidated.



The water flow through the heat exchangers of the unit should not be fall below Δt 7K measured at the following conditions:

Cooling mode: 35°C dry bulb ambient temperature, 7°C water outlet temperature.



When starting the unit for the first time, it is necessary to load it with clean water with chemical-physical characteristics such as to prevent corrosive phenomena or deposits of any kind. For this purpose, it is advisable to check annually the stability of the pH.

4.12 Chemical characteristics of the water

In the following table there are, just as an indication, the main values of chemical and physical properties of the water to be respected to avoid corrosion or any sediment. To this purpose it is advisable yearly check PH stability.

<p>Table key</p> <p>+ Good resistance under normal conditions</p> <p>0 Corrosion problems may occur especially when more factors are valued 0</p> <p>- Use is not recommended</p>	<p>Important Note: The following parameters can also influence the corrosion resistance</p> <p><u>Temperature:</u> The data in the table are based water temperature of 20°C unless otherwise is stated.</p> <p><u>Presence of oxidants</u> in the environment: guidelines regarding the oxygen content are shown in Table 3.</p> <p><u>Product form,</u> heat treatment and presence of intermetallic phases: The data in the table is based on untreated raw material.</p>
--	---

WATER CONTENT	CONCENTRATION (mg/l or ppm)	TIME LIMITS Analyze before	Plate Material		Brazing Material		
			AISI 304	AISI 316	COPPER	NICKEL	STAINLESS STEEL
Alkalinity (HCO ₃ ⁻)	< 70	Within 24 h	+	+	0	+	+
	70-300		+	+	+	+	+
	> 300		+	+	0/+	+	+
Sulphate ^[1] (SO ₄ ²⁻)	< 70	No limit	+	+	+	+	+
	70-300		+	+	0/-	+	+
	> 300		+	+	-	+	+
HCO ₃ ⁻ / SO ₄ ²⁻	> 1.0	No limit	+	+	+	+	+
	< 1.0		+	+	0/-	+	+
Electrical conductivity ^[2] (Refer to Table 3 for oxygen content guidelines)	< 10 µS/cm	No limit	+	+	0	+	+
	10-500 µS/cm		+	+	+	+	+
	> 500 µS/cm		+	+	0	+	+
pH ^[3]	< 6.0	Within 24 h	0	0	0	+	0
	6.0-7.5		+	+	0	+	+
	7.5-9.0		+	+	+	+	+
	9.0-10		+	+	0/+ ^[4]	+	+
	>10.0		+	+	0	+	+
Ammonium (NH ₄ ⁺)	< 2	Within 24 h	+	+	+	+	+
	2-20		+	+	0	+	+
	>20		+	+	-	+	+
Chlorides (Cl) (Refer to Table2 for temperature- dependent values)	<100	No limit	+	+	+	+	+
	100-200		0	+	+	+	+
	200-300		-	+	+	+	+
	300-700		-	0/+	0/+	+	-
	>700		-	-	0	+	-
Free chlorine (Cl ₂)	< 1	Within 5 h	+	+	+	+	+
	1-5		-	-	0	+	-
	> 5		-	-	0/-	+	-
Hydrogen sulfide (H ₂ S)	< 0.05	No limit	+	+	+	+	+
	>0.05		+	+	0/-	+	+
Free (aggressive) carbon dioxide (CO ₂)	< 5	No limit	+	+	+	+	+
	5-20		+	+	0	+	+
	> 20		+	+	-	+	+
Total hardness ^[5] (Refer to "Scaling Document" for scaling a spect of hardness effect)	4.0 - 11 °dH	No limit	+	+	+	+	+
	70 - 200 mg/l CaCO ₃		+	+	+	+	+
Nitrate ^[1] (NO ₃ ⁻)	< 100	No limit	+	+	+	+	+
	> 100		+	+	0	+	+
Iron ^[6] (Fe)	< 0.2	No limit	+	+	+	+	+
	> 0.2		+	+	0	+	+
Aluminium (Al)	< 0.2	No limit	+	+	+	+	+
	> 0.2		+	+	0	+	+
Manganese ^[6] (Mn)	< 0.1	No limit	+	+	+	+	+
	> 0.1		+	+	0	+	+

CHLORIDE CONTENT	MAXIMUM TEMPERATURE					
	20°C	30°C	60°C	80°C	120°C	130°C
= 10 ppm	SS 304	SS 304	SS 304	SS 304	SS 304	SS 316
= 25 ppm	SS 304	SS 304	SS 304	SS 304	SS 316	SS 316
= 50 ppm	SS 304	SS 304	SS 304	SS 316	SS 316	Ti
= 80 ppm	SS 316	SS 316	SS 316	SS 316	SS 316	Ti
= 200 ppm	SS 316	SS 316	SS 316	SS 316	Ti	Ti
= 300 ppm	SS 316	SS 316	SS 316	Ti	Ti	Ti
=700 ppm	SS 316	SS 316	Ti	Ti	-	-
=1000 ppm	SS 316	Ti	Ti	Ti	-	-
> 1000 ppm	Ti	Ti	Ti	Ti	-	-

In order to prevent corrosive phenomena or deposits of any nature it is recommended to:

- Empty the evaporator before any maintenance work is carried out;
- Do not clean the evaporator with unsuitable mechanical systems, such as drill bits or high-pressure jets;
- Do not clean with too aggressive cleaning agents. Before using a chemical detergent, check the compatibility with the construction materials of the exchanger.
- During winter stops, carefully empty the heat exchanger.



In case of long stops, leave the heat exchanger completely filled with adequate glycol water or completely empty.

4.12.1 Prevention of risk of freezing of the utility exchanger

The water contained inside the user exchanger, if not properly additivated, could freeze and consequently lead to the user exchanger breaking down. During operation of the unit this could occur due to insufficient water flow or too low water temperature. In order to prevent such situations from occurring, the unit is equipped as standard with a device that detects the presence of flow (differential pressure switch or vane flow switch) and an antifreeze probe placed on the water pipe out of the unit. Both devices provide for manual reset as a factory standard in the event of intervention.



It is compulsory to subject the aforementioned preventive devices (water differential pressure switch/flux switch and frost sensor) to periodic checks to ensure that they are functioning properly.



Tampering with and/or altering the above-described operation of the aforementioned preventive devices (water differential pressure switch/flux switch and frost protection probe) relieves the Company of any liability in the event of damage to the unit resulting from the freezing of the consumer heat exchanger.

4.13 User circuit minimum water content



Each chiller requires a minimum water content within the hydraulic circuit of the user, in order to ensure proper operation of the unit, preventing a large number of starts and stops of the compressors that could reduce the life cycle of the unit itself.

RAH MC VS U Kp	402	502	602	652	752
Min. Volume (l)	2100	2700	3500	3500	3900

4.14 Filling the hydraulic circuit

- Before filling, check that the installation drain valve is closed.
- Open all pipework, heat pump and terminal unit air vents.
- Open the shut off valves.
- Begin filling, slowly opening the water valve in the filling group outside the unit.
- When water begins to leak out of the terminal air vent valves, close them and continue filling until the pressure gauge indicates a pressure of 1.5 bars.

The installation should be filled to a pressure of between 1 and 2 bars. It is recommended that this operation be repeated after the unit has been operating for a number of hours (due to the presence of air bubbles in the system). The pressure of the installation should be checked regularly and if it drops below 1 bar, the water content should be topped-up. If frequent top-ups are required, check all connections for leaks.

4.15 Emptying the installation

- Before emptying, place the mains switch in the “Off” position.
- Make sure the filling group valve is closed.
- Open the drainage valve outside the unit and all the installation and terminal air vent valves.



If the fluid in the circuit contains anti-freeze, it **MUST** not be allowed to run away to drain. It must be collected for possible re-cycling or for correct disposal.

4.16 Microchannel condensing coil

The condensing coils are made up of a series of flat rectangular-shape tubes containing micro channels, to favourite heat exchange tubes are in contact through an aluminium sheet with a suitable window to favourite the thermal exchange with air. On each side of the coil there is a manifold receiving refrigerant in gaseous state from compressor discharge and in liquid state after condensation. All the components of the air/Freon heat exchanger are made up of aluminium alloy, the condensing coils are totally made up of aluminium alloy expressly developed to increase the resistance to corrosive agents and the thermal exchange with air. All the parts the exchanger is made up of, are connected by joints brazed in inert atmosphere, to grant the maximum chemical stability, so minimizing the galvanic effect.

Aluminium is considered an “active” metal because if in contact with oxygen, oxidizes in very short time, creating a very hard surface film, strong and able to be regenerated, which protect the material from deterioration. In normal conditions, so with an atmosphere with PH between 5 and 8 free from acidity and basicity peaks, if the oxide layer is not removed, aluminium is not damaged by corrosion phenomena. The microstructure used to build the exchanger, but especially the ambient conditions it works in, are consequently fundamental factors to grant exchanger corrosion resistance.

The coil is protected against corrosion thanks to the high quality of the aluminium alloy and to the special surface protection given by spray deposition of epossidic coating.

If the environment of the unit installation site is strongly aggressive, a special surface coating obtained by electrodeposition is also available as an option.

4.16.1 Corrosive environmental conditions

Areas that can prove the aluminium coils corrosion resistance include coastal areas, high populated urban areas and industrial sites; there also are some special applications which, even if not included in the a.m. areas, can also be dangerous, like ports and airports, high traffic zones, sewage plants, power plants, areas near to chemical industries, breweries, food processing or incineration plants. In these circumstances, the high presence of pollution agents in the air, favourites the formation of electrolytes, conductors of electricity if dissolved in water favouring in this way the activation of corrosive phenomena. In the a.m. circumstances, protect the aluminium exchangers surface with special treatments which increase their lifetime without compromising the heat exchange efficiency.

Near the coastal areas for example, the humidity in the air is rich of sodium chloride and sulphur, which in contact with metal can easily start corrosion phenomena. Moreover the saline atmosphere, which is itself high corrosive, acts as activator in presence of industrial emissions. This is the reason why the industrial/marine context is the worst situation in terms of corrosion.

Industrial areas, high populated urban ones and those near port and airports, are instead characterized from an high concentration in the air of Sulphur (SO₂ –SO₃) and Nitrogen (NO_x) derived from carbon and fossil hydrocarbons combustion. These airborne substances, fall down to the ground as acid rain and low PH dews. Besides near industrial areas, there are in the air also parcels of metal oxides, chlorides, sulphates, sulphuric acid, carbon and its compounds, parcels that in contact with oxygen, water or steam can be high corrosive, able so to corrode many materials, among which aluminium, iron, steel, brass, copper and nickel.

4.16.2 Microchannel aluminium condensing coils with AiAX_Coating treatment (Optional ECP)

They are made up of aluminium alloy and assembled using brazed joints. Coils, after a washing and drying process, and after the application of a primer, are black spray painted. The water-based substance is composed of very high chemical resistance resins which grant flexibility to resist to thermal contractions/expansions and UV rays granting a mechanical resistance as well. The surface applied material thickness is about 25 µm and involves a heat transmission lost of about 2%.



The exchangers treated with surface protection paint, even if protected again corrosion, must anyway be periodically inspected (never more frequently than 6 months under non-aggressive operating conditions, 3 months otherwise) to check the real condition of the surface protection. If it has been scratched or totally or partially damaged, the uncovered area must be once more protected with a new protective treatment.



If the unit is installed in strongly windy areas, near coasts or deserts or in areas subjects to wind and/or sand storms, inspect the unit more frequently (every three months) to check the real condition of the surface protection.

4.17 Electric connections: preliminary safety information

The electric panel is located inside the unit at the top of the technical compartment where the various components of the refrigerant circuit are also to be found. To access the electrical board, remove the front panel of the unit:



Power connections must be made in accordance to the wiring diagram enclosed with the unit and in accordance to the norms in force.



Make sure the power supply upstream of the unit is (blocked with a switch). Check that the main switch handle is padlocked and it is applied on the handle a visible sign of warning not to operate.



It must be verified that electric supply is corresponding to the unit electric nominal data (tension, phases, frequency) reported on the label in the front panel of the unit.



Power cable and line protection must be sized according to the specification reported on the form of the wiring diagram enclosed with the unit.



The cable section must be commensurate with the calibration of the system-side protection and must take into account all the factors that may influence (temperature, type of insulation, length, etc.).



Power supply must respect the reported tolerances and limits: If those tolerances should not be respected, the warranty will be invalidated.



Flow switches must be connected following the indication reported in the wiring diagram. Never bridge flow switches connections in the terminal board. Guarantee will be invalidated if connections are altered or not properly made.



Make all connections to ground provided by law and legislation.



Before any service operation on the unit, be sure that the electric supply is disconnected.



The power line and the unit external safety devices must be sized in order to ensure the correct voltage at the maximum operating conditions of the unit reported in the wiring diagram of the unit.



FROST PROTECTION

If opened, the main switch cuts the power off to any electric heater and antifreeze device supplied with the unit, including the compressor crankcase heaters. The main switch should only be disconnected for cleaning, maintenance or unit repair.

The unit must be powered by a 4-wire cable (3 phases +GND), if the power supply is 400 V73PH/50 Hz +GND. On demand, power supplies different from standard are available (check on the unit nameplate and wiring diagram).

Connect the phases to the input clamp of the main switch and the ground conductor to the dedicated clamp. Use a power supply cable with suitable section and as short as possible to avoid voltage drops.

Protect the power supply cable upstream the unit by means of an automatic switch with suitable size and features. The power supply cable section and the automatic switch size, can be found in the electrical components table attached, as well as the main switch size.

The cable entry is shown in the dimensional drawing of the unit attached to the Handbook. It must be suitably protected in compliance with the local regulations in force.

If the power supply cable entry is from the top, make a drop-break fold.



Before anyhow intervene on the unit, slightly verify that the electrical circuits of the device have not been damaged during the transport. Especially check that all the screws of the clamps are correctly tightened, and that the cable insulation is intact and in good conditions.

The conductors for the phases power supply cable, must be connected to the free clamps to the unit main switch entry; the ground conductor must be connected to the dedicated pre-arranged clamp (PE).

4.18 Electric data



The electrical data reported below refer to the standard unit without accessories.
In all other cases refer to the data reported in the attached electrical wiring diagrams.



The line voltage fluctuations can not be more than $\pm 10\%$ of the nominal value, while the voltage unbalance between one phase and another can not exceed 1%, according to EN60204. If those tolerances should not be respected, please contact our Company.
The use of the unit with a power supply with higher variations than those indicated will invalidate the warranty.

RAH MC VS U Kp		402	502	602	652	752
Power supply	V/~ Hz	400/3/50+GND	400/3/50+GND	400/3/50+GND	400/3/50+GND	400/3/50+GND
Control board	V	24 Vac	24 Vac	24 Vac	24 Vac	24 Vac
Auxiliary circuit	V/~	230/1	230/1	230/1	230/1	230/1
Fans power supply	V/~	400/3	400/3	400/3	400/3	400/3
Line section	mm ²	185	2x120	3x95	3x95	3x120
PE section	mm ²	120	120	150	150	185



Electric data may change for updating without notice. It is therefore necessary to refer always to the wiring diagram present in the units.

5. UNIT START UP

5.1 Preliminary checks

Before starting the unit the checks detailed in this manual of the electric supply and connections (par. 4.20), the hydraulic system (par. 4.11) and the refrigerant circuit (par. 5.1.4), should be performed.



Start-up operations must be performed in accordance with the instructions detailed in the previous paragraphs.



If it is required to switch the unit on and off, never do this using the main isolator: this should only be used to disconnect the unit from the power supply when the unit is to be permanently off. Isolation will result in no supply for the crankcase heater and on start up the compressor could be seriously damaged.

5.1.1 Before start-up



Damage can occur during shipment or installation. It is recommended that a detailed check is made, before the installation of the unit, for possible refrigerant leakages caused by breakage of capillaries, pressure switch connections, tampering of the refrigerant pipework, vibration during transport or general abuse suffered by the unit.

- Verify that the unit is installed in a workmanlike manner and in accordance with the guidelines in this manual.
- Check that all power cables are properly connected and all terminals are correctly fixed.
- The operating voltage between phases R S T is the one shown on the unit labels.
- Check that the unit is connected to the system earth.
- Check that there is no refrigerant leakage.
- Check for oil stains, sign of a possible leak.
- Check that the refrigerant circuit shows the correct standing pressure on the pressure gauges (if present) otherwise use external ones.
- Check that the Schrader port caps are the correct type and are tightly closed.
- Check that crankcase heaters are powered correctly (if present).
- Check that all water connections are properly installed and all indications on unit labels are observed.
- The system must be flushed, filled and vented in order to eliminate any air.
- Check that the water temperatures are within the operation limits reported in the manual.
- Before start up check that all panels are replaced in the proper position and locked with fastening screws.



Do not modify internal wiring of the unit as this will immediately invalidate the warranty.



Crankcase heaters must be powered at least 12 hours before start up (pre-heating period) To do this, isolate the compressor(s), fans and pump(s) in the electrics box and then switch on the main isolator (heaters are automatically supplied when the main switch is closed). The crankcase heaters are working properly if, after several minutes, the compressor crankcase temperature is about 10÷15°C higher than ambient temperature.



During the 12 hours pre-heating period it is also important to check that the label OFF is shown on the display or that the unit is on stand-by mode. If there is an accidental start-up before the 12 hours pre-heating period has elapsed, the compressors could be seriously damaged and therefore the warranty will immediately terminate .

5.1.2 Commissioning

The unit commissioning must be carried-out by a skilled refrigeration technician authorized by the manufacturer.



Before starting the unit for the first time or after a long period of stop, verify that the parameters set on the microprocessor are coherent with the required working conditions.

To switch the device ON, turn the main switch to ON, to power the unit. Then press the ON/OFF key on the microprocessor keyboard, positioning it on ON.

If the remote ON/OFF contact is closed, the circulation water pump, if present, will immediately start. After a delay time, settable by microprocessor, also the fans will start and then the different compressors in relation to the required cooling capacity to satisfy the present thermal load.

Once the unit has reached a stable operation regime, the technicians must verify the group working parameters and verify that:

- a) the safety high pressure switches are right installed and calibrated;
- b) on the external safety valves it is shown the calibration pressure and that the value is the one foreseen.
- c) No refrigerant leakage is present

The collected data must to be recorded on the commissioning report attached to this manual.



A copy of the commissioning report, duly filled, must be sent to the manufacturer, to make the warranty valid.



During the commissioning, the technician must check that the safety (high and low pressure switches, water differential pressure switch, anti-freeze thermostat etc.) and control devices (regulation thermostat, condensation pressure regulation device etc) properly work.

5.1.3 By-pass line between suction and discharge (if present)

A by-pass line may be present between suction and discharge to ensure adequate overheating on the discharge side.

If the value of this overheating is lower than 25°K, the by-pass is activated by injecting hot gas into the suction line in order to raise the exhaust temperature and bring the overheating value down to an acceptable level.

In such units, it is essential to check these issues:

- the valves on the by-pass line between the supply and suction are fully open;
- Solenoid valves located on the by-pass lines operate on time to bring the overheat value in the supply line down to the correct value;
- Thermostatic valves are set to keep at least 8°K of overheating at the evaporator side.



Modifying the adjustment sets of the thermostats and solenoids valves placed on the by-pass line could irreversibly compromise compressor operation.
It is strongly recommended not to do so.

5.1.2 Device and security Set-point

Device		Set-point	Differential	Reset
Cooling mode	°C	23	2	----
DHW mode	°C	50 * **	2	----
Anti-freeze thermostat	°C	4,5	2	Manual
High-pressure safety valve	Bar	23	----	----
High pressure switch	Bar	22	----	Manual
Low pressure switch	Bar	2,3***	0,7	Automatic

* Default values. Different values can be set on request

** With RP accessory

*** Water outlet 7°C



If the unit is required for heating/cooling only (without domestic hot water production) the internal parameter of the microprocessor FS1 has to be modified from 2 to 1 in order to avoid configuration alarms. Please contact the company for support.

5.1.3 Controls during unit operation

- Check the rotation of the compressors and fans. If the rotation is incorrect, disconnect the main switch and change over any two phases of the incoming main supply to reverse motor rotation (only for units with three-phase fan motors).
- After several hours of operation, check that the sight glass has a green colour core: if the core is yellow moisture is present in the circuit. In this event it is necessary for dehydration of the circuit to take place. This must be performed by qualified people only. Check that there are no continuous vapour bubbles present at the sight glass. This would indicate a shortage of refrigerant. A few vapour bubbles are acceptable.

5.2 Operation of the refrigerant gas detection sensor

5.2.1 Starting the unit

Each time the unit is switched on (Power-On), a self-calibration procedure is carried out on the sensor which lasts 300 seconds. During this time:

- The refrigerant leakage alarm is signalled by means of a red light alarm on the front of the electrical panel and the U20-U21 contact on the terminal board switches
- The 24 Vac auxiliary circuit and the 230 Vac circuit are not powered
- The forced ventilation of the compressor compartment by means of the ATEX emergency fan is activated.

If the procedure is successful, the sensor becomes operational and immediately:

- The red light alarm on the front of the electrical panels goes out and the U20-U21 contact switches
- All auxiliary circuits are powered
- The forced ventilation of the compressor compartment by means of the ATEX emergency fan is deactivated

The unit is in ON mode and it is ready to start.

5.2.2 Operation

The operation of the sensor is based on two alarm thresholds:

- Lower threshold set at 20% LFL (Lower Flammable Limit) with automatic alarm reset
- Upper threshold set at 30% LFL (Lower Flammable Limit) with manual alarm reset

If, during normal unit operation, the sensor detects a refrigerant concentration above the threshold values, an alarm is activated in the unit (it switches OFF) and immediately:

- The refrigerant leakage alarm is signalled by means of a red light alarm on the front of the electrical panel and the U20-U21 contact on the terminal board switches
- The 24 Vac auxiliary circuit and the 230 Vac circuit are disconnected from the power supply
- The forced ventilation of the compressor compartment by means of the ATEX emergency fan is activated

This situation persists until the sensor is reset; this can either occur automatically or it must be done manually depending on the threshold value exceeded.



By means of a differential pressure switch located on the air flow, it is possible to check that the ATEX emergency fan is actually working. During normal unit operation, the ATEX emergency fan is forcefully activated for 2 minutes every 20 hours.

Note: If the red light located on the electrical panel door lights up, it may indicate:

- Refrigerant leakage alarm
- Alarm due to lack of flow from the differential air pressure switch, which can be reset by disconnecting the device from the power supply
- ATEX emergency fan thermal alarm, which can be reset by resetting the thermal switch itself



If the ATEX emergency fan goes into the alarm condition, it stops, periodic forced ventilation is no longer carried out, it is signalled by a light and the machine switches OFF.

5.2.3 Resetting the sensor alarm and restoring unit operation

Automatic reset

This occurs only if the refrigerant concentration in the air detected by the sensor drops below the lower threshold, without having exceeded the upper threshold.

In this case, the sensor alarm disappears automatically:

- The red light alarm on the front of the electrical panels goes out and the U20-U21 contact switches;
- All auxiliary circuits are reactivated;
- The forced ventilation of the compressor compartment by means of the ATEX emergency fan is stopped.

The unit returns to ON mode and it is ready to start.

Manual reset

Before resetting the alarm and restoring normal unit operation, it is essential to identify and eliminate the causes that generated it. Only later will it be possible to reset the alarm by acting on the main switch (power OFF/ON). The sensor will then carry out the self-calibration procedure, after which (if successful) the unit can return to the ON operating state.



It is very important to reset the sensor after all traces of refrigerant have been dispersed from the compressor compartment, and that the sensor starts the self-calibration procedure in the environmental conditions in which it will normally operate.

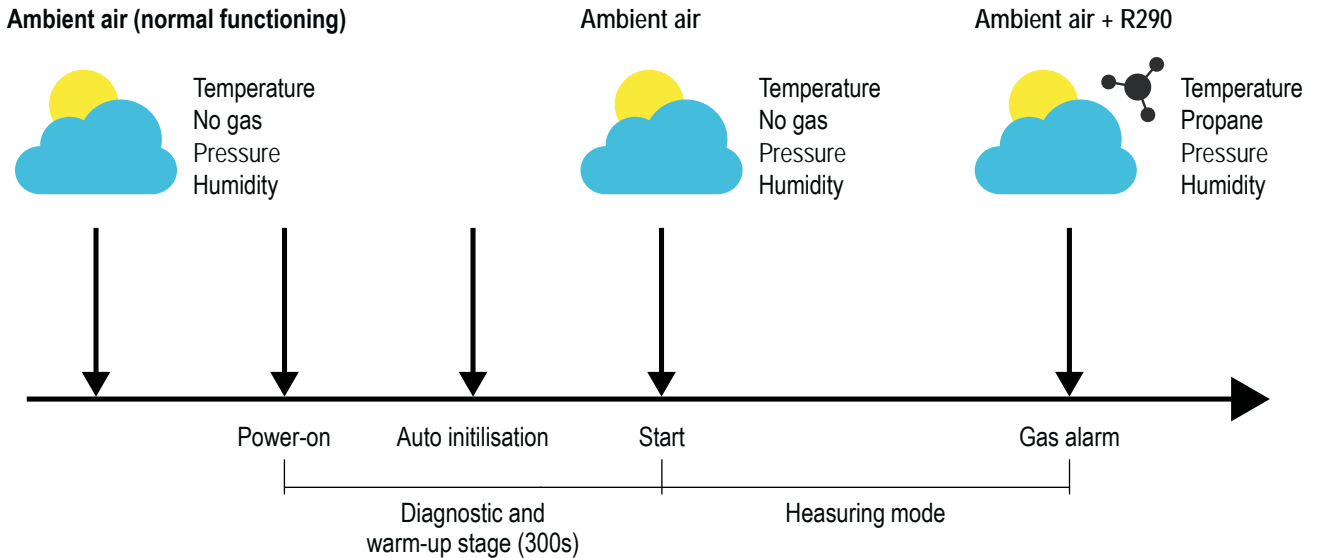

By means of the "U20-U21" contact in the terminal block of the electrical panel, it is possible to use the alarm signal of the leak detection sensor, for example to disconnect the power supply to one or more appliances located near the unit. This is a normally open and voltage-free contact. If the sensor is not in the alarm condition, the contact is closed; it opens if unit is not powered or if the sensor is in the alarm condition.



The sensor uses technology that does not require mandatory periodic calibrations. It is necessary to perform periodic visual and functional checks to make sure that the system is in perfect working order. These checks must be performed by personnel qualified to work on circuits containing flammable refrigerant gases, according to the methods and frequency described in the dedicated section of this manual ("Periodic checks of the refrigerant gas detection sensor").



During normal operation, the ventilation of the technical compartment is forced cyclically for 2 minutes every 20 hours.



If the periodic maintenance checks are not performed on the leak detection sensor within the required times, the unit will go into lockout. For further details, refer to the dedicated paragraph ("Periodic checks of the refrigerant gas detection sensor").



If the leak detection sensor is tampered with, if the required checks are not performed, or if non-original components are used or connections not in accordance with the design documents after made after maintenance work, the Company is automatically relieved of any liability related to any malfunctions.

5.3 Safety valves

The outlet connections of the external safety valves installed on the unit are equipped with a threaded connection, so they can be connected to a drain pipe if present and if the installation design and current local regulations allow it.

If provided, the valves must be individually directed in metal piping, to an area where the refrigerant spill cannot damage people or things.



The refrigerant spilled from safety valves is an high pressure, high temperature and high speed discharged gas. Its flow may damage things and people coming in direct contact with it.



The opening of safety valves comes with a noise whose intensity may damage hearing capabilities of surrounding people.

The piping diameter must be no smaller than the safety valves draining pipe ones; refrigerant leaks in the line must be as small as possible and in any case should not cause a reduction in the discharge rate of the valves.

The piping outlet connection must be done so to avoid that rain water, snow, ice, and dirt can accumulate and obstruct the pipeline.

The valve discharge must be at a suitable distance from other equipments, systems or ignition sources; the discharged refrigerant must not accidentally enter buildings.

In any case, any pipes on the safety valves discharge must be made in compliance with current laws and regulation.

The risk of lightning strikes related to the presence of the metal pipe conveying the discharge of the safety valve can be assessed according to IEC 62305, CEI EN 62305 and other applicable standards if it is deemed appropriate to do so. The analysis must consider, among other factors, the ceranonical probability that is typical of the installation site, the conformation of the surroundings and all other elements present near the installation site, such as towers, skyscrapers, bell towers, etc. These elements are often far more relevant than the installation itself in defining the risk of lightning strikes and the consequent actions to limit their effects.

Unless we know what characterises the area, it is not possible to make such an analysis that can be considered effective and correct.

Similarly, the installation of an air-termination unit is usually not necessary and in cases where it is, it must necessarily be carefully dimensioned by the plant designer.



The risk of lightning, fire, earthquake, particular snow phenomena, tornadoes and natural events in general cannot in any way be assessed by the manufacturer and are therefore the responsibility of the system designer.

5.4 Position of the control panel



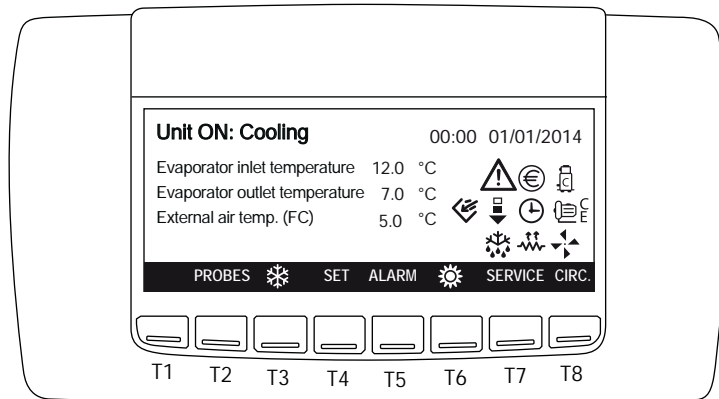

5.5 Description of the control panel



5.5.1 Display icons

Icon	Meaning	Icon	Meaning
	Number of compressors in operation.		Indicates that the electric heaters are active.
	Water pump		Economy or ON/OFF by timetable.
	Indicates that the fans are working.		Free cooling is active (not available).
	Indicates that an alarm is active.		Domestic hot water (not available).
	Economy function		Indicates that the defrost is active.
	Unloading function (not available).		

5.5.2 Key function

T2:	PROBES	Allows to read the value of the probes configured
T3:		Allows to switch on the unit in cooling mode
T4:	SET	Allows to read and modify the set point
T5:	ALARM	Allows to read and reset the alarms
T6:		Allows to switch on the unit in heating mode (not available).
T7:	SERVICE	Allows to enter the SERVICE menu
T8:	CIRC	Allows to read the main information of the circuits (compressor status, water pump status, pressure probe value,...)

When the unit is turned on, the display will be as follows:

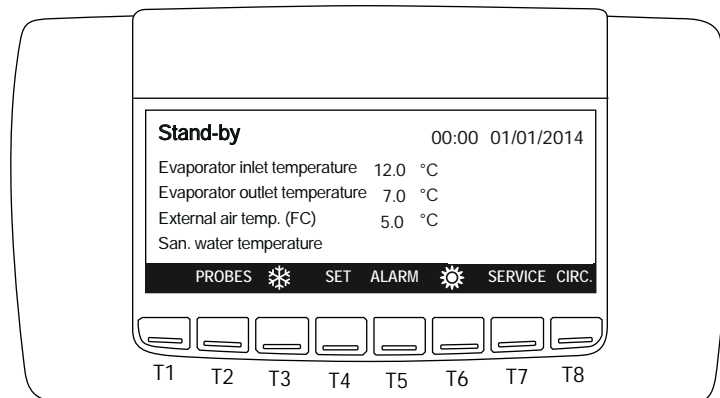

5.6 To remote the control

5.6.1 Remote keyboard connection (VGI890)

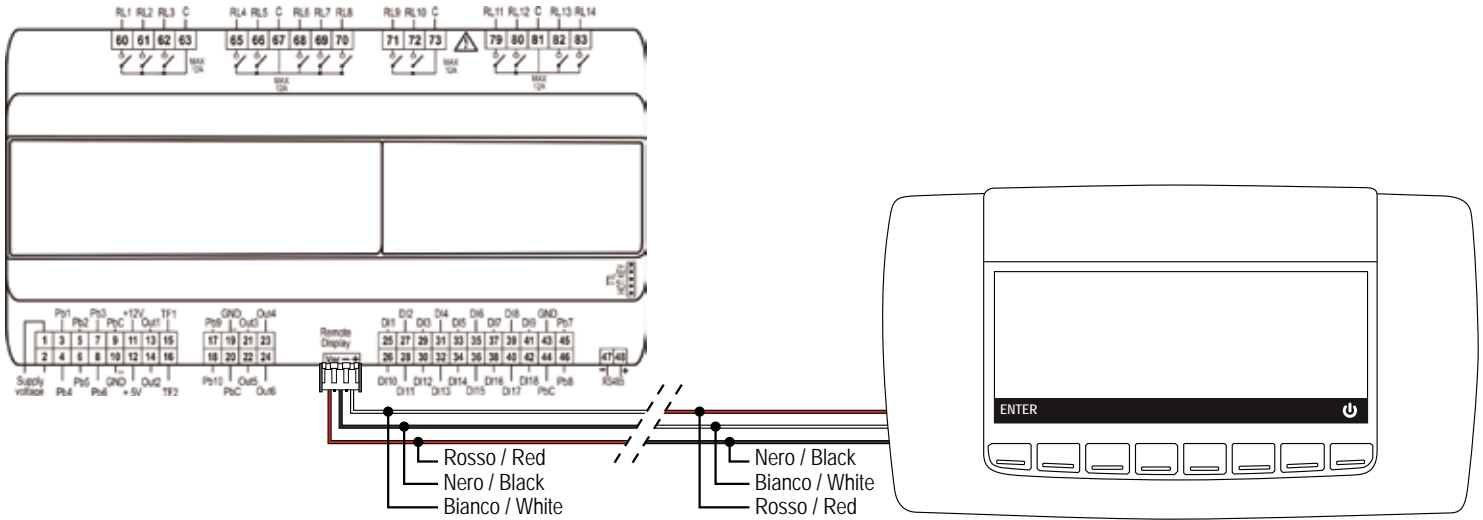

Special care must be taken when connecting the keyboard to the IChill200D, to avoid irreparable damage to the controller or/and keyboard

- In case of power supply failure (wire black or red), the keyboard doesn't work.
- In case of communication problems, the display shows "noL" message.

5.6.2 Panel mounting connection diagram

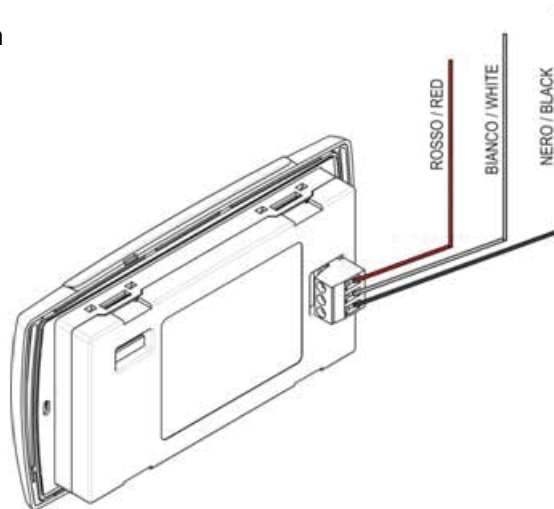

5.6.3 Wall mounting connection diagram

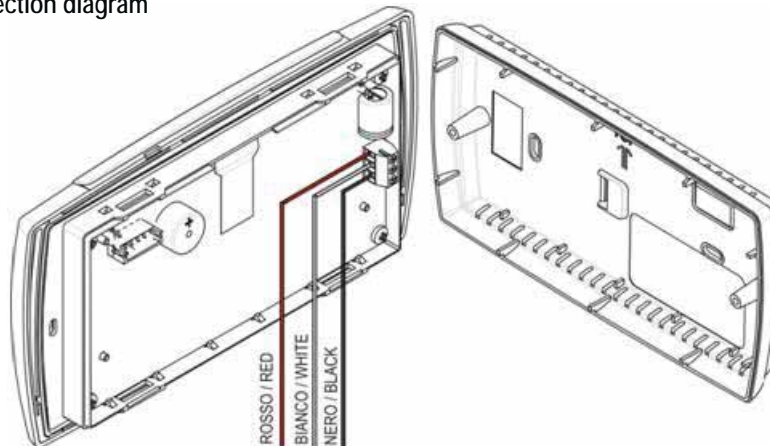

6. USE

6.1 Switch the unit on

Unit switch-on and switch-off can take place:

- From the keyboard
- From digital input configured as remote ON/OFF

6.1.1 Switch the unit on from the keyboard

Cooling mode

To start the unit in the cooling mode, press the  key. The icon  appears on the display.

If requested, the compressor safety delay countdown starts and the compressor icon flashes. The water pump will be activated after few seconds, and then, once the compressor countdown has finished, the compressor starts and the icon remains on. The display shows the user water inlet temperature and Domestic hot water inlet temperature.

In stand-by mode, the controller gives the possibility to:

- display the set values
- manage alarms, theyr display and reports.



If it is required to switch the unit on and off, never do this using the main isolator: this should only be used to disconnect the unit from the power supply when the unit is to be permanently off. Isolation will result in no supply for the crankcase heater and on start up the compressor could be seriously damaged.

6.1.2 Cooling mode

The display shows the typical visualization during the unit working in:

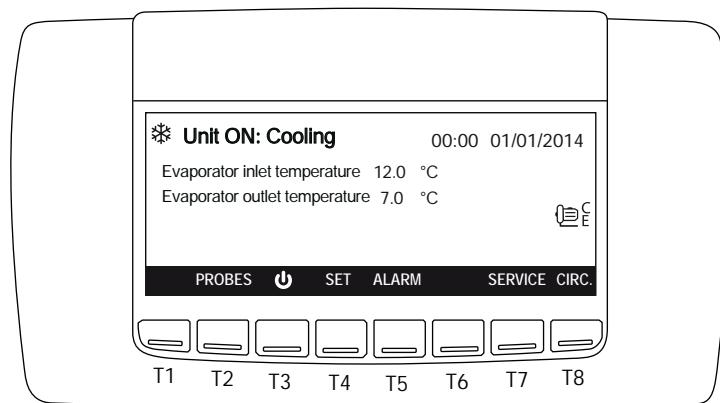

6.1.3 Switch the unit on from from digital input

If the unit is switch off by remote digital input, the display shows:

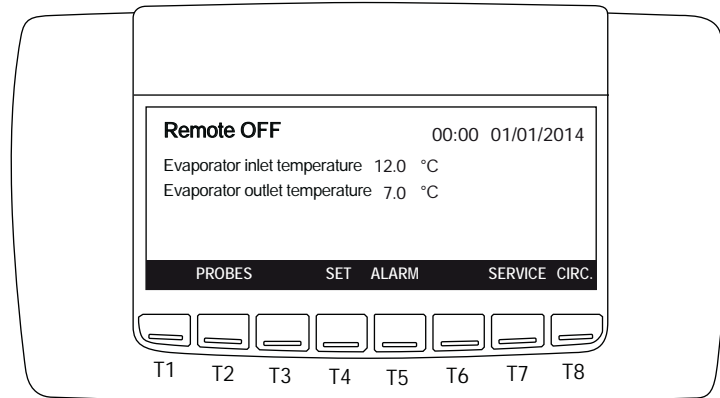

When the digital input is not active, the unit is in OFF mode

- The remote input has the priority with respect to the keyboard
- The unit can only be switched-on and off if the remote input is activated

6.2 Stop

To switch the unit off press the key .

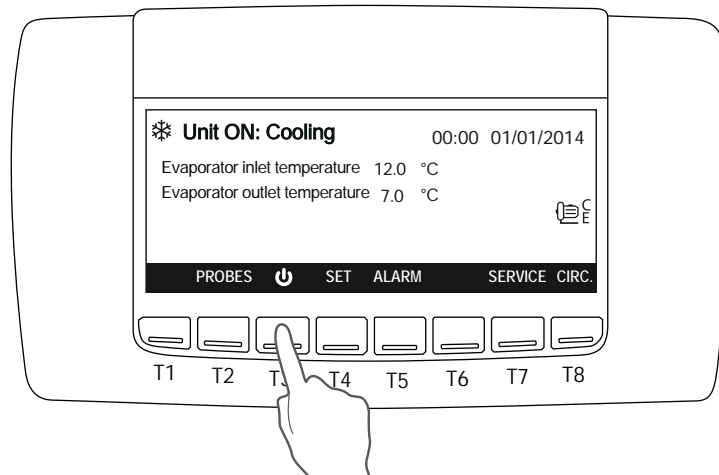

6.3 Set point

To change the set-point from the main screen, press SET.

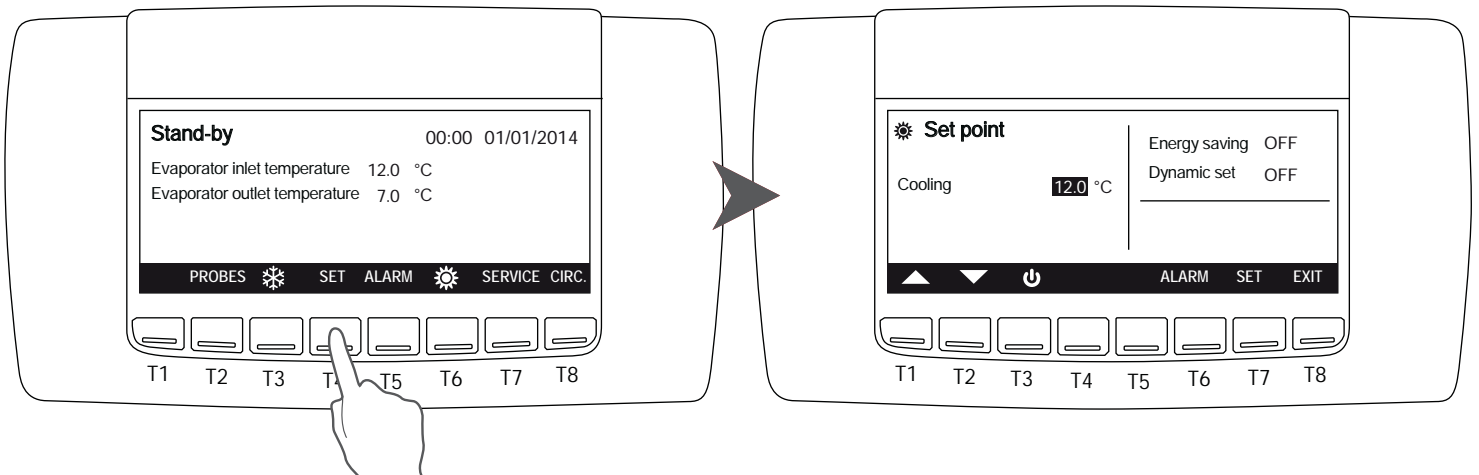

To modify the values, move the cursor with T1; press SET to select, the value starts blinking, change the data pressing T1 and T2. Once the required value is reached, press again SET to confirm.

The cursor will automatically position itself on the next value, to modify it, repeat the operation just described.

In this screen it is also possible to verify (but not modify) whether the energy saving mode and dynamic set are active.

Press EXIT to go back to the main menu.



All set points refer to the return temperature from the plant. In case hot water at 45°C is requested and the Δt is 5°C, then the set point must be set at 40°C. In case the Δt is 8°C, then the set point must be set at 37°C. In case cold water is requested, for example at 15°C and the Δt is 5°C, then the set point must be set at 20°C. If the Δt is 8°C, then the set point must be set at 23°C.

6.3.1 Adjustable parameters

The adjustable set point that can be modified by the end user are:

Function	Adjustment limit	Default value
Cooling set-point	10÷25°C	23°C
Password	(Contact the company)	



The units are supplied with a very sophisticated control system with many other parameters that are not adjustable by the end user; these parameters are protected by a manufacturer password.

6.4 PROBES key

To view all the parameters measured by the sensors of the unit press PROBES;

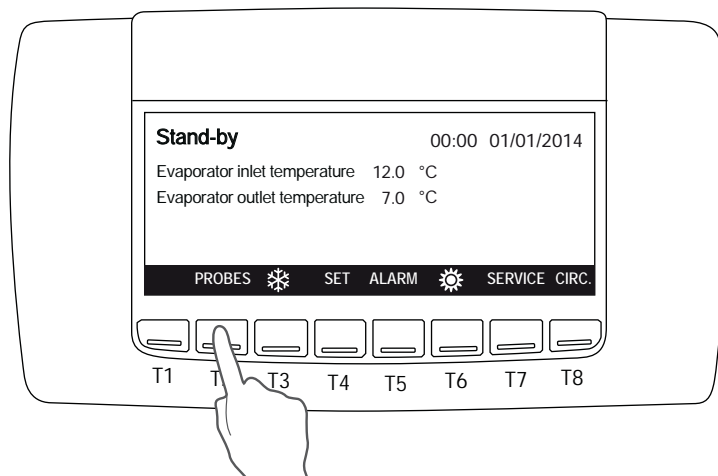

By pressing the T5 key, all relevant values of the circuit will be displayed

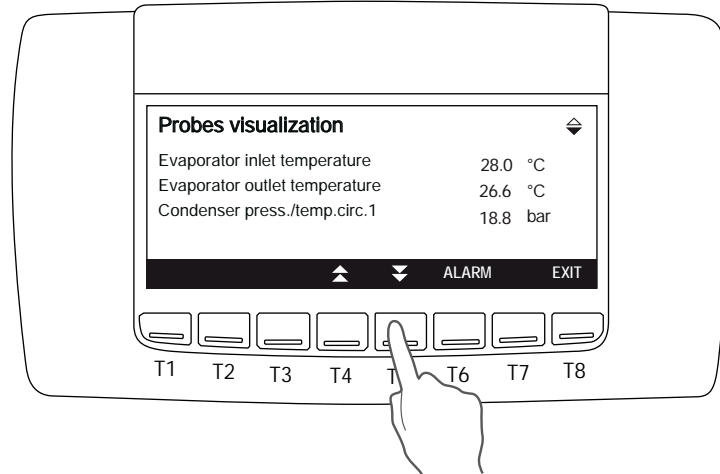

Press EXIT to go back to the main menu.

6.5 ALARM key

When the alarm occurs, the display shows the icon  blinking.
Press ALARM key to read the alarm status:

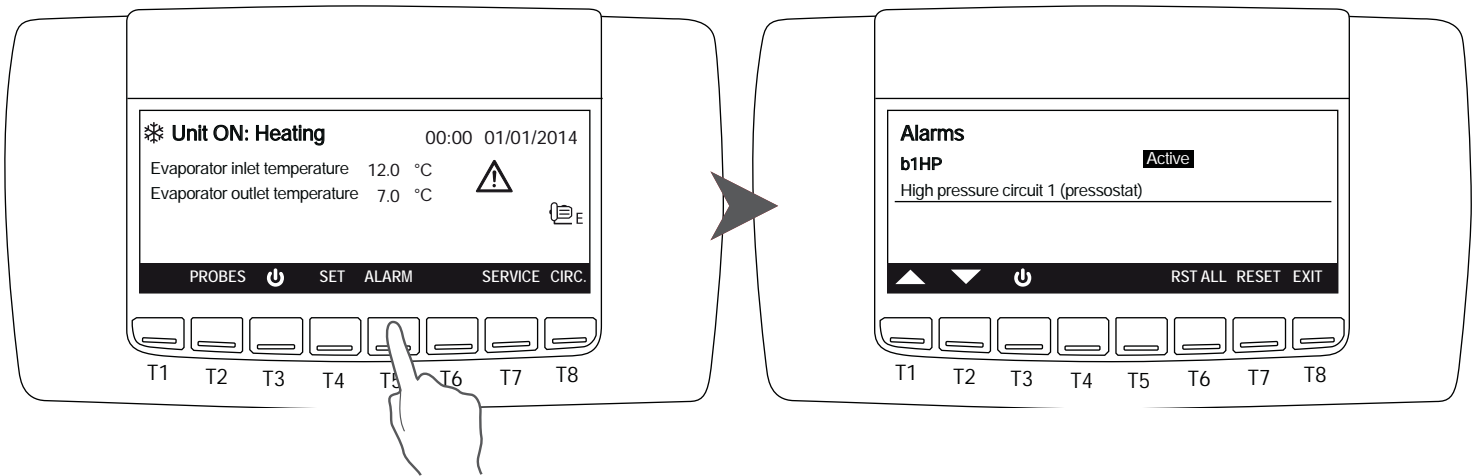

The alarm status can be:

- **Reset:** the alarm is not active and it is possible to reset it. Press T1 and T2 keys to select the alarm to select it and press RESET key to reset the alarm.
- **Password:** in this case the alarm is no longer active, but you need a password to reset it (please contact the Company).
- **Active:** the alarm is still active and it is not possible to reset it.

In case more resettable alarms are present, it's possible to reset all of them at once pressing RST ALL key.
In any case, even if all the alarms are reset, they remain present in the alarm history.

6.6 CIRC key

Pressing CIRC can view the different parameters of the unit:

Pressing T4 and T5 you move from one screen to another while with T1 and T2 you scroll through the menu items. Press ENTER key to view the values.

State of the compressors; the display shows compressors present in each circuit and the activation status of each one.

Color black: compressor running

Color white: compressor on standby

In case of use of compressors in part-loading (typically screw compressors) an icon appears to the right of the compressor showing the level of step control.

In case of use of On/Off compressors (Scroll) no icon appear to the right of the compressor.

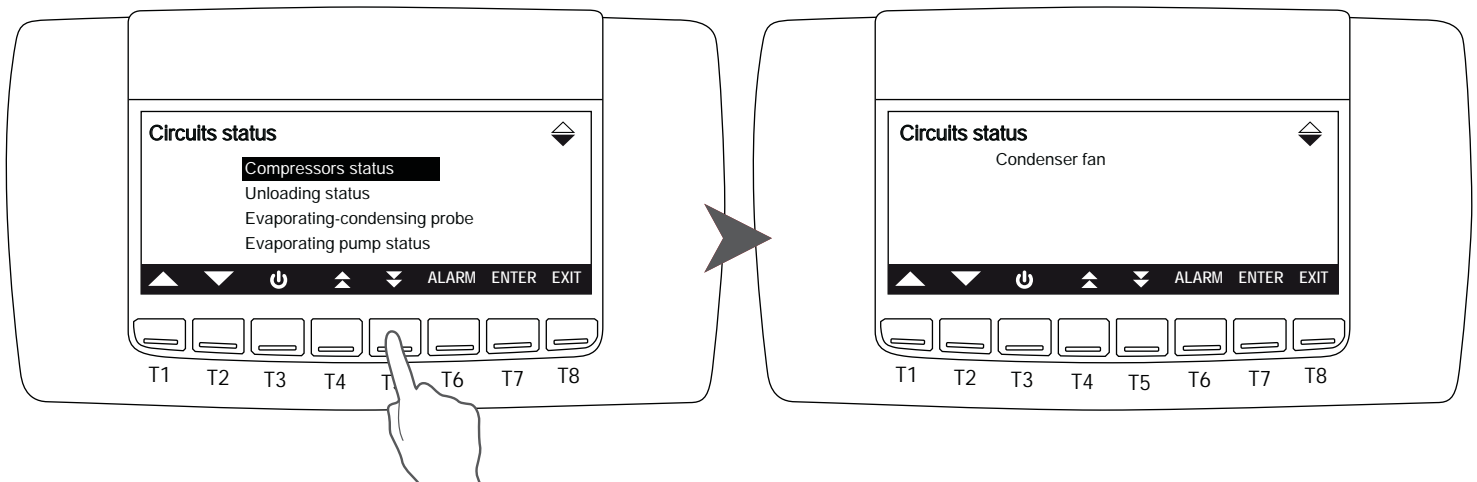
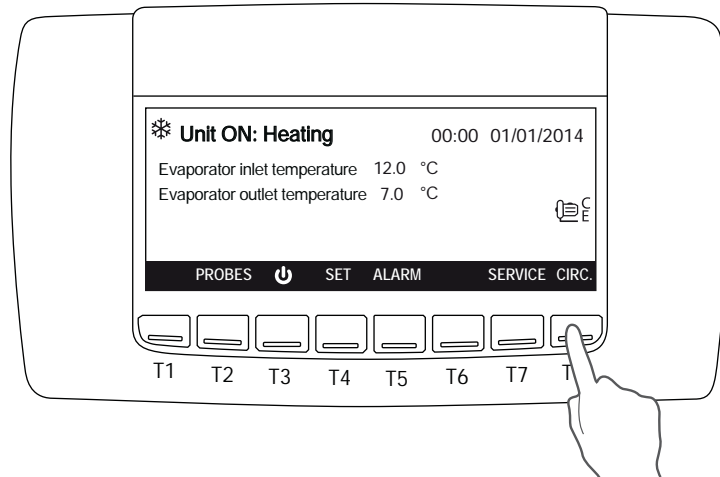

Compressor status

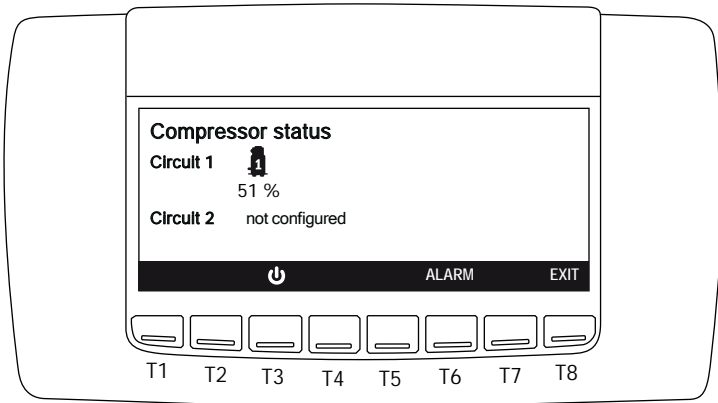

Unloading status

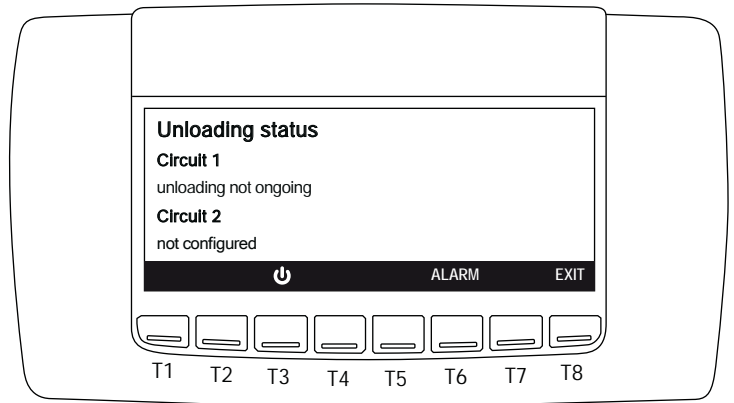

Evaporating-condensing probe

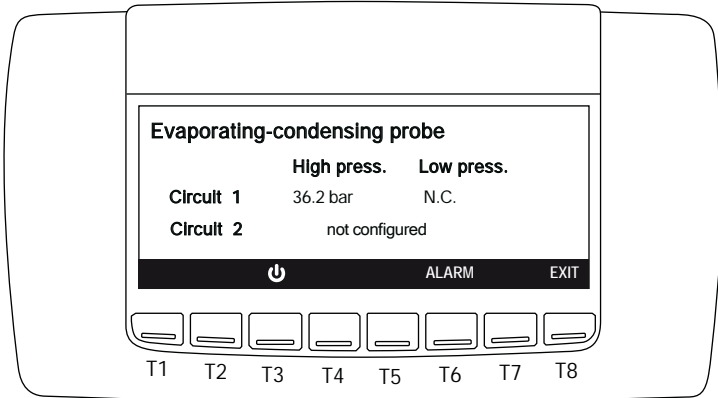

Evaporator pump status

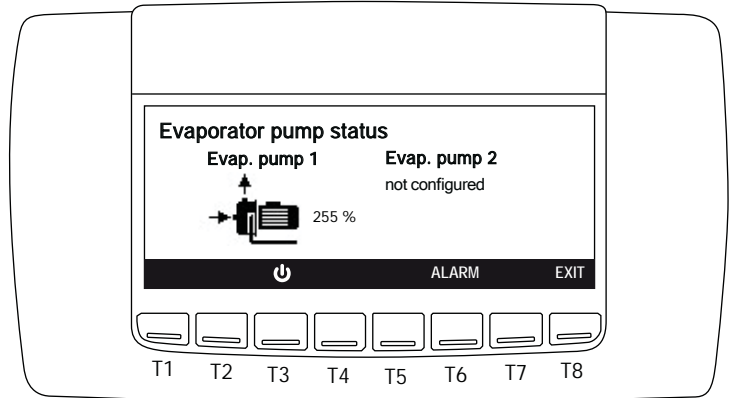



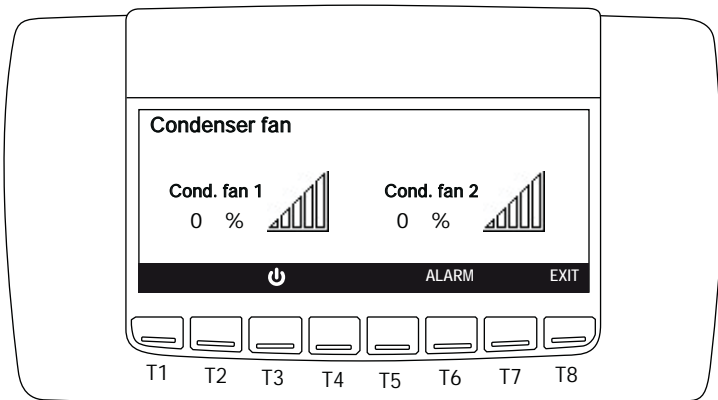



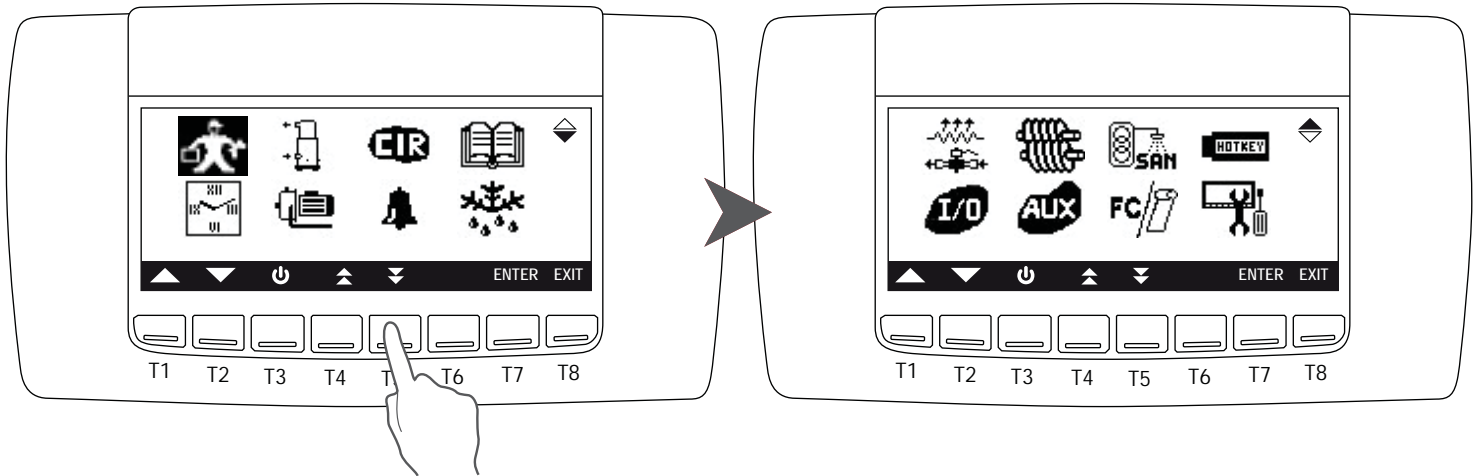









Condenser fan



6.7 SERVICE key



Press the **SERVICE** key to access the following menus:

 Setting parameters (for service only)	 Electrical heater and pump down valve status
 Time and date setting	 I/O status (Inputs and Outputs)
 Compressors status	 Screw compressor information (Not configured)
 Pumps	 Auxiliary outputs
 Circuit maintenance	 Domestic hot water (if available)
 Display of alarms	 Free cooling and Solar panel visualization (if available)
 Alarm history	 Upload and download parameter map with Hot Key
 Defrost (if available)	 Control panel

Press T4 key to display all the menu available.

To modify and set the parameters move the cursor using the T1 and T2, press **ENTER**, to select the required menu, and then **SET** to select the desired value.

Change the parameters by pressing the T1 and T2, and then press **SET** again to confirm.

Press the **EXIT** key to return to the main menu.

6.7.1 Service parameters setting

To enter service menu select  moving between the icons with T1 and T2 keys and press ENTER.

The system prompts you to enter the password to access to different levels of security.

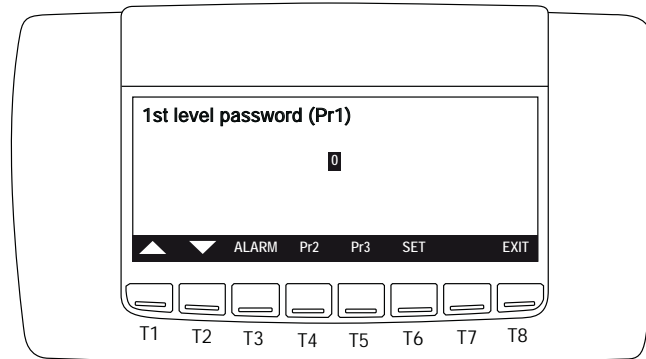

The first level allow to modify some parameters as for example heating and cooling set points and dynamic set points. Press SET key, with T1 modify the password to 1 then press SET again to confirm.

The display show:

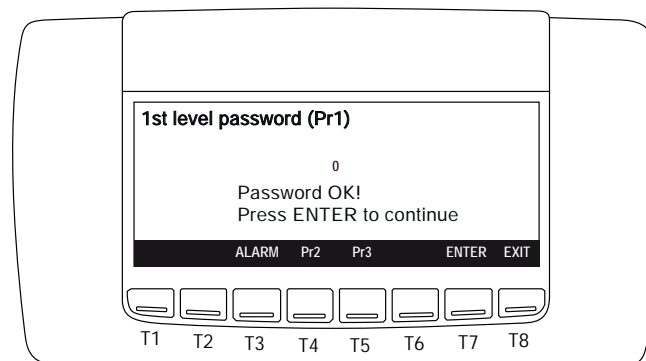

Press T1 and T2 to scroll through different groups of parameters. With password level 1 you could only change the Set Point (St), dynamic Set point (Sd), and parameters of sanitary circuit (FS); the unit must be switched on. Press ENTER to enter in the group of parameters. Other parameters can only be modified by service with a dedicated password. Other parameters could be modified by service people only with a dedicated password.

Parameters list:

Code	Meaning	Code	Meaning
St	Set point	US	Auxiliary output
dP	Main visualization	FA	Fan
CF	Configuration	Ar	Antifreeze
Sd	Dynamic set	dF	Defrost
ES	Energy saving	FS	Sanitary water
Cr	Compressor racks	AL	Alarms
CO	Compressor		

To modify the value of the parameter: press T1 or T2 to select the parameter to modify then press SET the value start to blinking, press T1 or T2 to modify, than press SET again to confirm.

The values available in the group of parameters "Set point" (St) are: summer set point (St01), winter set point (St04), summer regulation band (St07) and winter regulation band (St08).

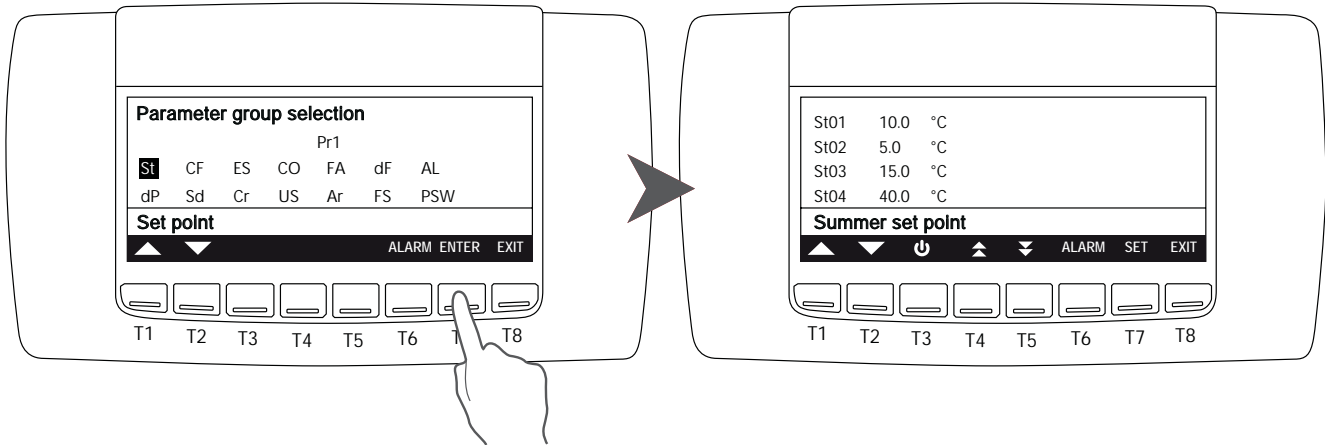

The values available in the group of parameters "Dynamic set point" (Sd) are: dynamic set point: summer offset (Sd01), dynamic set point: winter offset (Sd02), dynamic set point: summer outside temp. (Sd03), dynamic set point: winter outside temp. (Sd04), dynamic set point: summer differential temp. (Sd05) and dynamic set point: winter differential temp.(Sd06).

For more informations about the parameters see par. 6.3.1 and 6.3.2.



6.7.2 Setting date and time

To enter this menu select  moving between the icons with the keys T1 or T2 and press ENTER.

Press T1 or T2 to select the value you want to edit than press SET. The selected parameter will start blinking, press T1 or T2 to set the value and than press SET to confirm.

Pressing T5 it is possible to read the information about the Energy saving, ON/OFF scheduling and time bands. To modify the hour of the time band and to enable the function is necessary to insert the password, in case you do not have a password, you can only view the different parameters..

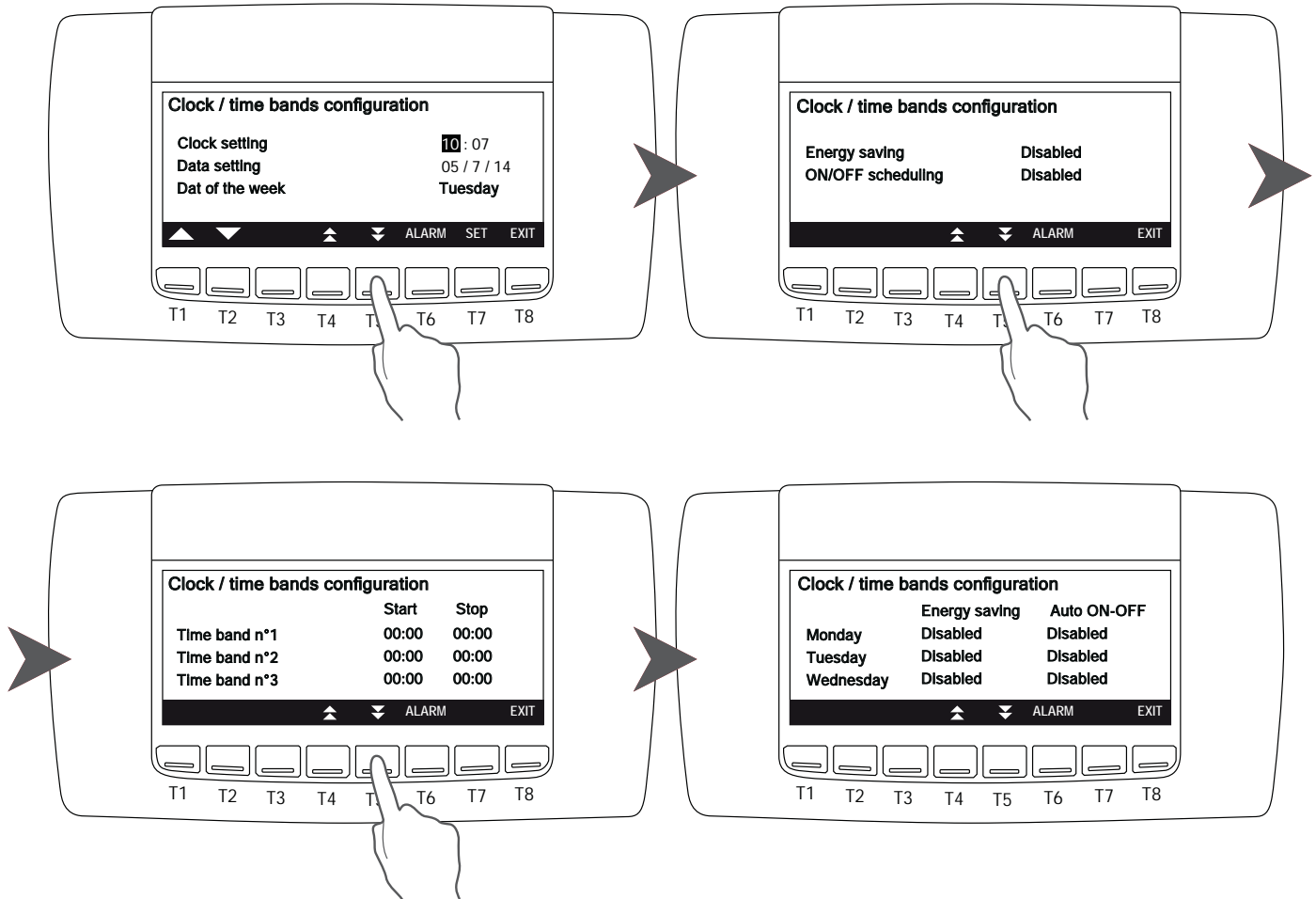

6.7.3 Compressor maintenance



To enter this menu select  moving between the icons with the keys T1 or T2 and press ENTER.

It is possible to display the compressors working hour and the number of activations. Select the circuit with the keys T1 or T2 than press ENTER to display the parameters. The disabling function of the compressors ENB/DIS is only possible by service people.

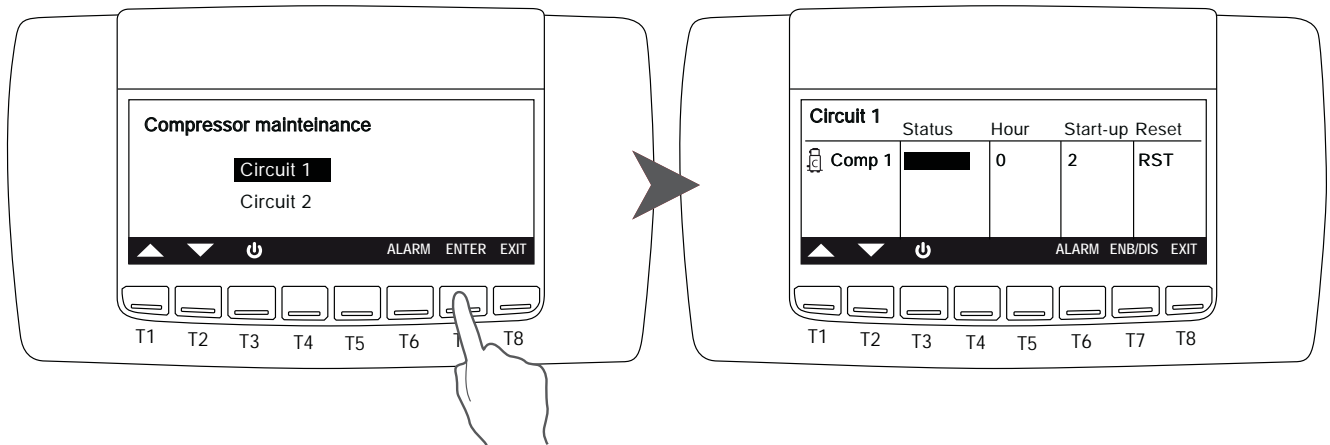

6.7.4 Water pumps



To enter this menu select  moving between the icons with the keys T1 or T2 and press ENTER.

It is possible to display the working hours of water pumps. The function RESET is only possible by service people.

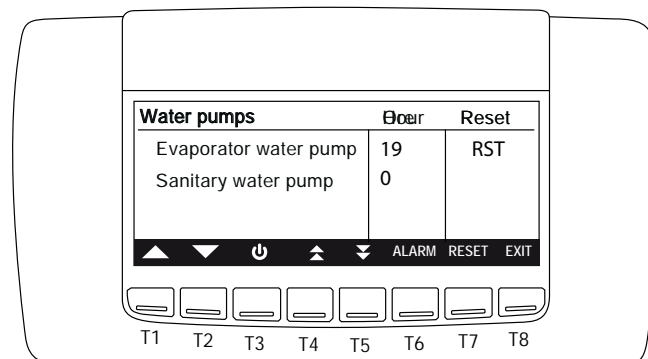

6.7.5 Circuit maintenance



To enter this menu select  moving between the icons with the keys T1 or T2 and press ENTER.

It is possible to display the status of the circuits. The function ENB/DIS is only possible by service people.

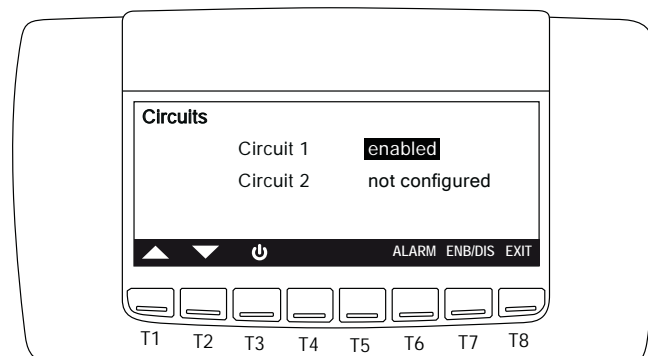

6.7.6 Alarms

To enter this menu select  moving between the icons with the keys T1 or T2 and press ENTER.

For the management of alarms see par. 6.5.

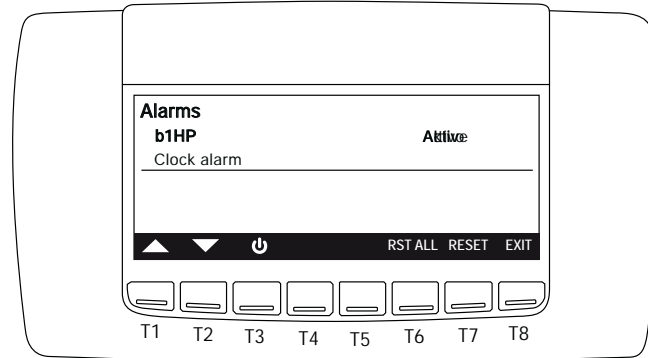

6.7.7 Alarm log

To enter this menu select  moving between the icons with the keys T1 or T2 and press ENTER.

Pressing T4 and T5 it is possible to read the last 99 alarms. The function of reset of all alarms RST ALL is only possible by service people.

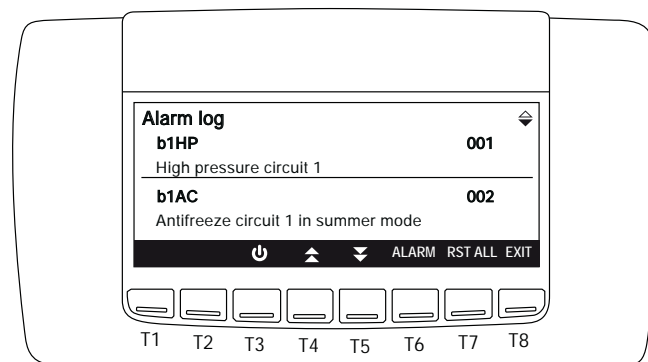

Press T4 and T5 to display all the available parameters.

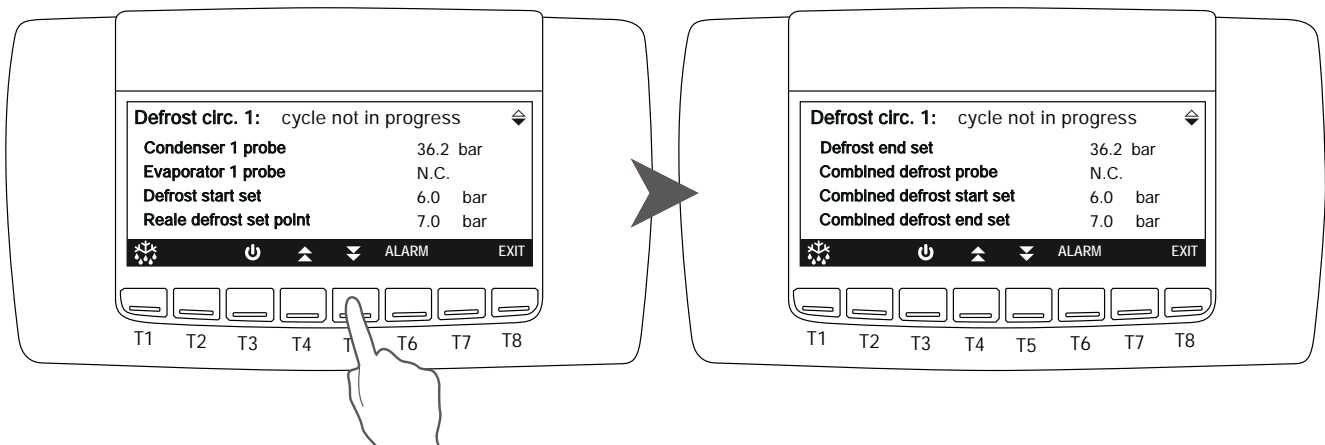

6.7.9 Eletrical heater



To enter this menu select  moving between the icons with the keys T1 or T2 and press ENTER. It is possible to read the status of the electrical heaters.

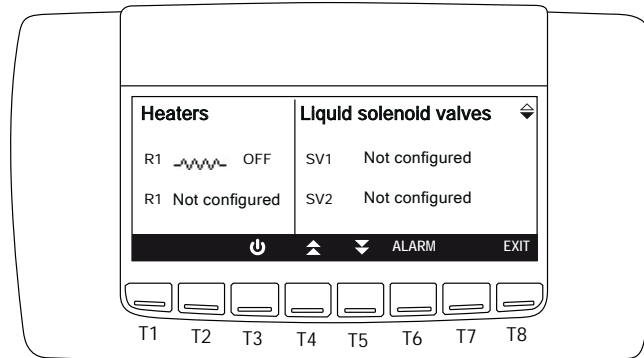

6.7.10 I/O Status (Input/Output)



To enter this menu select  moving between the icons with the keys T1 or T2 and press ENTER. It is possible to display: probes status, analog input and output, digital input and output.

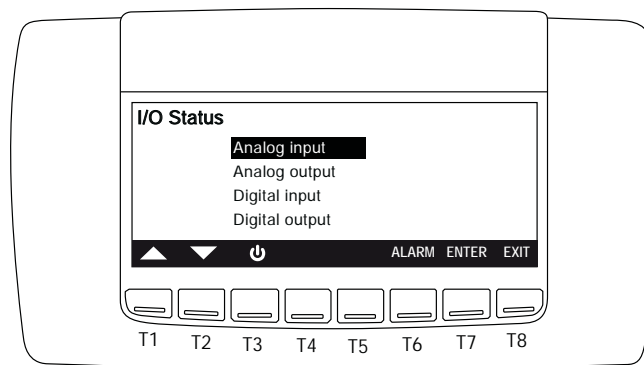

6.7.11 Screw compressor (If available)



To enter this menu select  moving between the icons with the keys T1 or T2 and press ENTER. In the main screen it is possible to display the discharge temperature and the liquid injection set point. Press T1 or T2 keys to select the required circuit than press ENTER key to read the discharge temperature and the status of the valves.

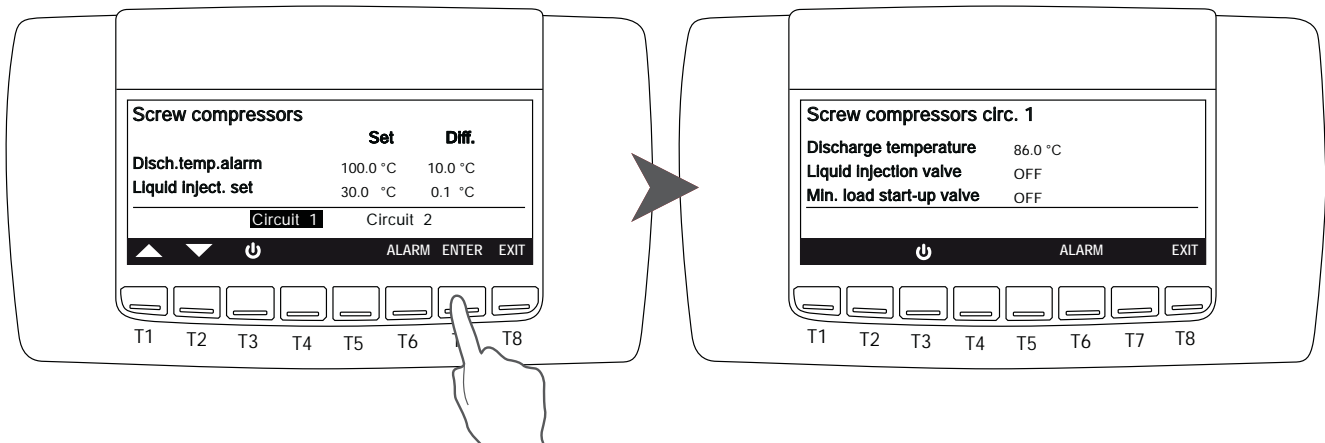

6.7.16 Control panel

To enter this menu select  moving between the icons with the keys T1 and T2 and press ENTER.

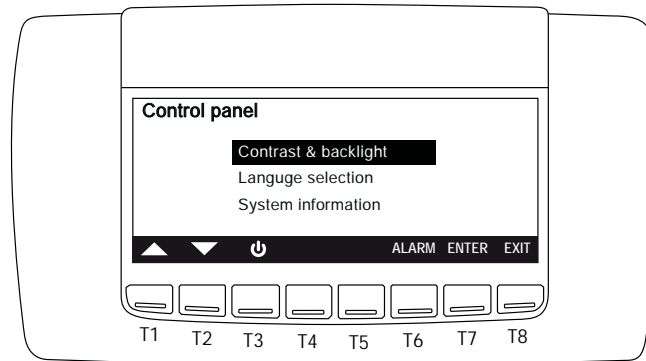

6.8 Acoustic signal silencing

Pressing and releasing one of the keys; the buzzer is switched off, even if the alarm condition remains in place.

6.9 Emergency Stop

The emergency stop gives the possibility to stop the unit for the minimum possible time. If an emergency stop is required, follows this procedure:

- Turn the main switch (red and yellow) OFF; the unit immediately stops.
- Press the red emergency stop button as well.

6.9.1 Start after an emergency stop



Before restarting the unit, verify that the cause of the emergency stop has been eliminated

Restarting the unit proceeding as follows:

Turn the main switch ON; (this does not switch the unit ON and does not allow a restarting after a second voluntary action); Rotate the emergency stop button. The unit is thus restarted).

7. MAINTENANCE OF THE UNIT

7.1 General warnings

Maintenance can:

- Keep the equipment operating efficiently
- Prevent failures
- Increase the equipment life



It is advisable to maintain a record book for the unit which details all operations performed on the unit as this will facilitate troubleshooting.



Maintenance must be performed in compliance with all requirements of the previous paragraphs.



Use personal protective equipment required by regulations as compressor casings and discharge pipes are at high temperatures. Coil fins are sharp and present a cutting hazard.



If the unit is not to be used during the winter period, the water contained in the pipes may freeze and cause serious damage. In this event, fully drain the water from the pipes, checking that all parts of the circuit are empty including any internal or external traps and siphons.



Inside the unit, there can be high voltage zones. Any intervention on them, must be done by authorized personnel qualified in compliance with the local regulations in force.



The surfaces of the components in the compressor discharge side and in the refrigerant liquid line could reach very high temperatures and any contact can cause burns.



Before carrying out any kind of work on the machine, it is necessary to cut off the power supply from the electric panel, by turning the main switch to the OFF position



To carry on any intervention requiring the opening of the cooling circuit, follow this procedure:

- 1) activate the crankcase heater of the compressor for 4 hours minimum-
- 2) recover the refrigerant by means of an approved cylinder
- 3) make the vacuum in the circuit
- 4) flow the circuit with inert gas (nitrogen)
- 5) use orbital blades to dissect the pipes



Smoking is forbidden during maintenance operations.

7.2 Drive access

Access to the unit once installed, should only be possible to authorized operators and technicians. The owner of the equipment is the company legal representative, entity or person owns the property where the machine is installed.

They are fully responsible for all safety rules given in this manual and regulations. If it is not possible to prevent access to the machine by outsiders, a fenced area around the machine at least 1.5 meters away from external surfaces in which operators and technicians only can operate, must be provided.

7.3 Routine maintenance

The Owner must take care that the unit is adequately maintained, according to the indications contained in the Handbook and what required by current local laws and regulations.

The Owner must take care that the unit is periodically suitably inspected and maintained, according to the system type, size, age and functions and to the indication in the Handbook.



If leak detection instruments are installed on the system, they must be inspected at least once a year, to check that they work properly.

During its operation life the unit must be inspected and checked as stated by the current local laws and regulation. In particular, unless more restrictive specifications, follow the recommendation on the following table (see. EN 378-4. encl. D).

CASE	Sight Inspection (par. 4.2, p.ti a - l)	Pressure test	Leak detection
A	X	X	X
B	X	X	X
C	X		X
D	X		X

A	Inspection, after an intervention, with possible effects on the mechanical resistance or after a change of purpose or after a stop longer than 2 years; all unfit components must be replaced. Do not carry on checks with higher pressures than design ones.
B	Inspection following an intervention, or a relevant modification of the system or its components. The check can be restricted to the components involved in the intervention, but if a refrigerant leak is detected, a leak detection must be made on the all system.
C	Inspection following a change of the unit position. If there is the chance to have effects on the mechanical resistance, refer to point A.
D	Refrigerant leak detection after a justified suspicious. The system must be checked to find any leaks, using direct measures (devices able to find the leak) or indirect ones (deduction of the leak presence analysing the operational parameters), focusing attention on those parts which are more easily exposed to leaks (junctions, for example).



If it is detected a fault that endangers the reliable operation of the unit, it's necessary to rectified it before restart the unit.

7.3 Periodical checks



The start-up operations should be performed in compliance with all requirements of the previous paragraphs.



All of the operations described in this chapter **MUST BE PERFORMED BY TRAINED PERSONNEL ONLY**. Before commencing service work on the unit ensure that the electric supply is disconnected. The top case and discharge line of compressor are usually at high temperature. Care must be taken when working in their surroundings. Aluminium coil fins are very sharp and can cause serious wounds. Care must be taken when working in their surroundings. After servicing, replace the cover panels, fixing them with locking screws.

7.4.1 Electrical system and control devices

Actions	Frequency						
	Daily	Monthly	Every 2 months	Every 6 months	Once a year	Every 5 years	If required
Check that the unit works properly and that there are no alarms	X						
Visually inspect the unit		X					
Check unit noise and vibration		X					
Check safety devices and interlocks				X			
Check the unit performances				X			
Check the absorbed current of the components (compressors, fans, pumps, etc.)				X			
Check the supply voltage of the unit				X			
Check the connection of cables to the pre-arranged clamps				X			
Check contactors conditions and functioning					X		
Check microprocessor and display functioning					X		
Verificare il funzionamento del microprocessore e del display			X				
Check microprocessor set parameter values					X		
Eliminate any dust from electrical and electronic components				X			
Check probes and transducers functioning and calibration					X		
Check evaporator refrigerant level sensor functioning (if present)					X		
Check the state and function of the voltage-free contact "leakage alarm" identified with "U20-U21" in the terminals					X		
Perform the calibration procedure or the refrigerant leak sensor functional test (*)					X		

(*) Follow the section in the manual

7.4.2 Condensing coils fans and cooling circuit

Actions	Frequency						
	Daily	Monthly	Every 2 months	Every 6 months	Once a year	Every 5 years	If required
Visually inspect condensing coil		X					
Clean finned coils ⁽¹⁾				X			
Check the water flow and/or any leaks		X					
Check that the flow switch is working properly				X			
Clean the metallic filter on the water pipe ⁽²⁾				X			
Check fans noise and vibration		X					
Check fans supply voltage				X			
Check fans electrical connection					X		
Check proper operation and calibration of the fans speed regulation system					X		
Check 4 way valve proper operation (if present)					X		
Check 3 way valve proper operation (if present)					X		
Check presence of air the hydraulic circuit		X					
Check the color of the humidity display on the liquid line				X			
Check if there are any freon leaks				X			



⁽¹⁾ If the unit is installed in strongly windy areas, near coasts or deserts or in areas subjects to wind and/or sand storms, or near airports, industries or in places with high levels of air pollution in general inspect the unit more frequently (every three months) to check the real condition of the surface protection. follow the instructions given in the paragraph "Cleaning the microchannel condensing coils".



⁽²⁾ It can be carried out with a higher frequency (also weekly) depending on the Δt .

7.4.3 Compressor

Actions	Frequency						
	Daily	Monthly	Every 2 months	Every 6 months	Once a year	Every 5 years	If required
Visually inspect compressors		X					
Check compressor noise and vibration		X					
Check compressors supply voltage				X			
Check the compressors electrical connections					X		
Check the oil level in the compressors using the oil level indicator light.				X			
Check that the crankcase heaters are powered and working properly.		X					
Check the conditions of the compressors electrical cables and their connection to their clamps				X			



Monthly and daily procedure can be directly done by the Owner. The other interventions must be done by qualified and suitably trained personnel.



Do not start any cleaning operation before disconnecting the unit from the electrical power supply, turning the main switch to OFF Position. Do not touch the equipment with barefoot or wet /damp parts of the body.



Any intervention on the cooling circuit must be done by qualified and suitable trained technicians, licensed in compliance with current local laws and regulation.

7.4.4 Microchannel condensing coils cleaning

In order to grant the optimal unit operation and to keep the unit performances unchanged, periodically inspect the cleaning condition of the micro channel condensing coils and proceed with cleaning operation at least once per year if the unit is not installed in an high polluted zone, far from industrial areas or high populated centres. If it is instead installed in areas with high powders or Pollens concentration or near airports, industries or, in general, in high polluted areas, inspection and cleaning must be done every three Months.



It is important cleaning the surface of the microchannel coil, removing any solid residue which could impede the correct airflow worsening in that way the heat exchange. A frequent cleaning helps in keeping high unit performance values increasing condensing coil and unit itself lifetime.

To clean a not treated microchannel coil first of all remove the dirty on the exchangers surface using an industrial vacuum cleaner or compressed air. Only after the removal of any solid residue on the coil surface, it is possible starting the washing, which must be done with pure water without the addition of any chemical substances or other detergents that could damage the superficial oxide layer which protects the exchanger and, if damaged, could favour the activation of corrosion phenomena.



The use of pressure washers and chemical substances (or other detergents) to wash the surface of the microchannel coils is forbidden. If any damage will be caused by the high pressure jet, no warranty cover will be recognized on the unit.



When intervene on the unit, keep attention on avoiding to damage the coil surface by hitting it with the metal nozzle of the tools used for cleaning.

7.4.5 Periodic checks of the refrigerant gas detection sensor

It is mandatory to subject the refrigerant gas detection sensor to regular visual and functional checks in order to make sure that it is working properly and to guarantee a compliant level of safety. These checks must be performed by properly trained and qualified personnel, according to the procedures and frequencies described below.

Visual check

The visual check must be performed at least every 6 months and even more frequently if the environmental conditions in which the unit operates require it.

The purpose of the visual check is mainly to verify that:

- The sensor head is free of dust, dirt or any other residues
- The electrical wiring is intact and in accordance with the documentation accompanying the unit

Functional check

The functional check must be performed annually and in any case within the maximum limit of 400 total days passed with the sensor powered.



If the functional check of the sensor is not performed within the total 400 days, the unit will go into lockout and the following message will appear on the display: "Check sniffer alarm" and it can only be operated again after performing the functional check, with positive outcome, according to the procedure described.

To perform the functional check, it is necessary to have the special sample cylinder calibrated to deliver 500ml/min of a mixture containing 0.85% Propane in air (50% LFL) following the procedure described (to be read carefully before starting the operation).

1. Screw the flow meter (1) onto the cylinder and connect the clear tube between the cylinder and the adapter (2). Then screw the adapter onto the sensor head (3)

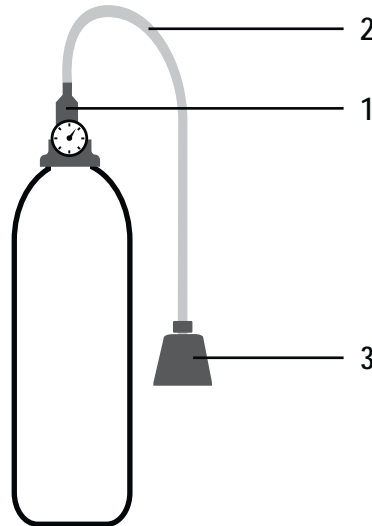

2. With the unit powered and operational, press the blue button located on the external part of the electrical panel
3. The unit will switch OFF and enter the "Check sniffer alarm" mode, which can be seen on the display, and it will remain in this condition for the next 10 minutes
4. Start dispensing 500ml/min of refrigerant and make sure that within the next 70 seconds the sensor goes into alarm because the maximum threshold has been exceeded (manual sensor reset) (*)
5. The ATEX emergency fans and the light alarms located on the electrical panel must be active
6. Remove the adapter previously screwed onto the sensor head and wait 5 minutes to allow the ventilation system to disperse any traces of refrigerant
7. Then reset the sensor by acting on the unit's main switch (power OFF/ON)
8. The sensor will carry out the self-calibration procedure and, if this is successful, the unit will return to the ON operating state
9. On the display, go to the dedicated screen and reset the counter, which will restart from 0 (**)
10. Reset the check sniffer alarm by pressing and holding the alarm button on the display for a few seconds



(*) If the alarm is not activated within 70 seconds from when the dispensing started, then it is necessary to replace the head.

(**) DIXEL interface to be accessed to reset the hour meter
Press the “service” key to access this screen

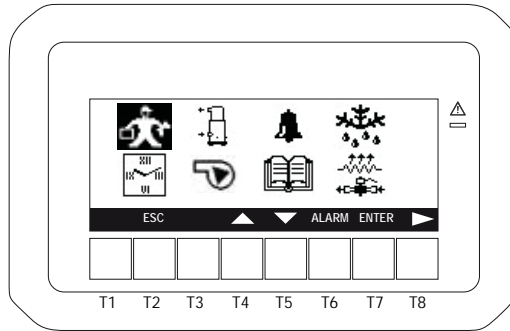

Access the menu dedicated to the compressors and select “Unit”

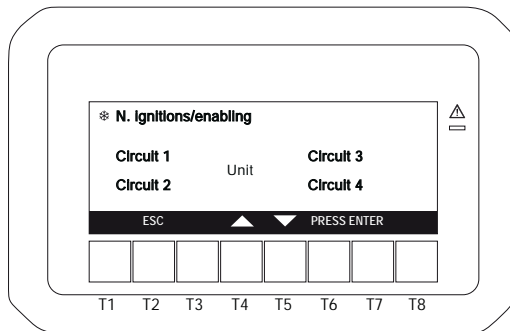

The following screen will appear, from which the hour meter can be reset

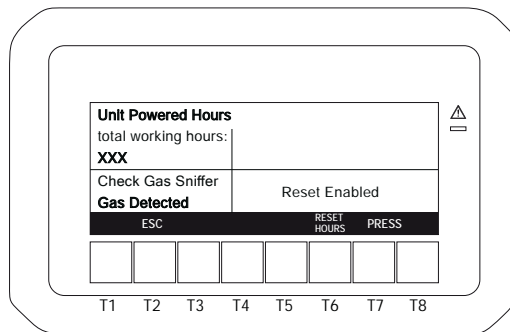

Any periodic check and/or maintenance operation on the sensor must be reported in a logbook indicating the date the check was performed, the name of the technician who performed the check, any anomalies found and the response times detected during the functional test.

In any case refer to the handbook of the detector supplied with the unit.

7.4.6 Microchannel coils treated with AiAX coating cleaning (optional ECP / PCP)

To clean the microchannel coils treated with AiAX coating, first of all remove the dirt on the exchangers surface using an industrial vacuum cleaner or compressed air. Only after the removal of any solid residue on the coil surface, it is possible starting the washing, which must be done with pure water, or water added with standard cleansing agents with PH between 4 and 10. In this case proceed with an abundant final rinse to remove any trace of the used detergent from the coil surface.

7.4.7 End of seasons

If the unit is to be left out of commission for a long period, the hydraulic circuit should be drained down. This operation is compulsory if the ambient temperature is expected to drop below the freezing point of the fluid in the circuit (typical seasonal operation). Before a new filling, the system must be washed.



During seasonal stops, if the unit's hydraulics and exchangers are to be drained, it is recommended that no water should be left even in small quantities in the shell and tube exchangers. The presence of water still in the shell and tube exchangers leads to a high risk of corrosion of the copper tubes.

7.4.8 Unit OFF

To stop the unit, press the ON/OFF key on the microprocessor, turning it on OFF position. If the unit will be OFF for more than 24 h turn the main switch to OFF position to cut the unit electrical power.

If any malfunction has occurred during the unit operation, solve it asap, in order to avoid that it will occur again at next operation.

7.5 Refrigerant circuit repair



If the refrigerant circuit is to be emptied, all the refrigerant must be recovered using the correct equipment.

For leak detection, the system should be charged with nitrogen using a gas bottle with a pressure reducing valve, until 15 bar pressure is reached. Any leakage is detected using a bubble leak finder. If bubbles appear discharge the nitrogen from the circuit before brazing using the proper alloys.



Never use oxygen instead of nitrogen: explosions may occur.

Site assembled refrigerant circuits must be assembled and maintained carefully, in order to prevent malfunctions.

Therefore:

- Avoid oil replenishment with products that are different from that specified and that are pre-loaded into the compressor.
- In the event of a gas leakage on machines using refrigerant R407C, even if it is only a partial leak, do not top up. The entire charge must be recovered, the leak repaired and a new refrigerant charge weighed in to the circuit.
- When replacing any part of the refrigerant circuit, do not leave it exposed for more than 15 minutes.
- It is important when replacing a compressor that the task be completed within the time specified above after removing the rubber sealing caps.
- When replacing the compressor following a burn out, it is advisable to wash the cooling system with appropriate products including a filter for acid.
- When under vacuum do not switch on the compressor.

8. DECOMMISSIONING

8.1 Disconnect the unit



All decommissioning operations must be performed by authorized personnel in accordance with the national legislation in force in the country where the unit is located.

- Avoid spills or leaks into the environment.
- Before disconnecting the machine please recover:
 - the refrigerant gas;
 - Glycol mixture in the hydraulic circuit;
 - the compressor lubricating oil.

Before decommissioning the machine can be stored outdoors, providing that it has the electrical box, refrigerant circuit and hydraulic circuit intact and closed.

8.2 Disposal, recovery and recycling

The frame and components, if unusable, should be taken apart and sorted by type, especially copper and aluminum that are present in large quantities in the machine.

All materials must be recovered or disposed in accordance with national regulations.



The refrigerant circuit of the unit contains lubricant oil that binds the disposal mode of components .

8.3 RAEE Directive (only UE)



The crossed-out bin symbol on the label indicates that the product complies with regulations on waste electrical and electronic equipment.
The abandonment of the equipment in the environment or its illegal disposal is punishable by law.

This product is included in the application of Directive 2012/19/EU on the management of waste electrical and electronic equipment (WEEE).

The unit should not be treated with household waste as it is made of different materials that can be recycled at the appropriate facilities. Inform through the municipal authority about the location of the ecological platforms that can receive the product for disposal and its subsequent proper recycling.

The product is not potentially dangerous for human health and the environment, as it does not contain dangerous substances as per Directive 2011/65/EU (RoHS), but if abandoned in the environment it has a negative impact on the ecosystem.

Read the instructions carefully before using the unit for the first time. It is recommended not to use the product for any purpose other than that for which it was designed, as there is a risk of electric shock if used improperly.

9. DIAGNOSIS AND TROUBLESHOOTING

9.1 Fault finding

All units are checked and tested at the factory before shipment, however, during operation an anomaly or failure can occur.



BE SURE TO RESET AN ALARM ONLY AFTER YOU HAVE REMOVED THE CAUSE OF THE FAULT; REPEATED RESET MAY RESULT IN IRREVOCABLE DAMAGE TO THE UNIT AND IMMEDIATELY VOID THE WARRANTY

Code	Alarm Description	Cause	Solution
ACF1	Configuration alarm	Wrong configuration of microprocessor control system.	Contact the company.
ACF2	Configuration alarm		
ACF3	Configuration alarm		
ACF4	Configuration alarm		
ACF5	Configuration alarm		
ACF6	Configuration alarm		
ACF7	Configuration alarm		
ACF8	Configuration alarm		
ACF9	Configuration alarm		
AEE	Eeprom alarm	Severe hardware damage in the microprocessor control system.	Switch OFF the unit and, after few second switch ON the unit; if the alarm appears again contact the service.
AEFL	User water flow switch alarm	Presence of air or dirtiness in the user hydraulic system.	Bleed carefully the user hydraulic system or check and clean the water strainer.
AEU _n	Compressor unloading alarm (only units with 2 compressors)	User water temperature is too high.	Wait until the user water temperature is lower.
AHFL	Domestic hot water flow switch alarm	Presence of air or dirtiness in the user hydraulic system.	Bleed carefully the user hydraulic system or check and clean the water strainer.
AP1	Alarm user inlet water temperature sensor	Wrong electrical connection, Sensor defect.	Check the electrical connection of the sensor to the terminal board, if correct call the service to replace the sensor.
AP10	Alarm safety domestic hot water sensor		
AP2	Alarm user outlet water temperature sensor		
AP3	Alarm pressure transducer		
AP4	Alarm finned coil sensor / defrost sensor		
AP5	Alarm domestic hot water inlet temperature sensor		
AP6	Alarm domestic hot water outlet temperature sensor		

Code	Alarm Description	Cause	Solution
AP7	Alarm ambient sensor	Wrong electrical connection, Sensor defect.	Check the electrical connection of the sensor to the terminal board, if correct call the service to replace the sensor.
AP8	Not used		
AP9	Not used		
AtE1	Evaporator water pump 1 overload		
AtE2	Evaporator water pump 2 overload		
B1 HP	High pressure switch circuit 1	<p>In heating mode: Insufficient user circuit water flow; Insufficient domestic hot water circuit water flow.</p> <p>In cooling mode: Insufficient air flow at the source fan; Insufficient domestic hot water circuit water flow.</p>	<p>Restore the correct user circuit water flow. Restore the correct domestic hot water circuit water flow.</p> <p>Restore the correct air flow to source fan. Restore the correct domestic hot water circuit water flow.</p>
b1AC	Anti-freeze alarm circuit 1 (cooling mode)	Too low water temperature	Check user temperature set point; Check user water flow.
b1AH	Anti-freeze alarm circuit 1 (heating mode)	Too low water temperature	Check user temperature set point.
b1dF	Wrong defrost circuit 1 (maximum time admitted)	Defrost time too long; Outside temperature outside the working limits; Refrigerant charge leakage.	Check defrost set point; Restore normal working conditions; Find leakage and repair.
b1hP	High pressure transducer alarm circuit 1	Transducer defect	Replace the faulty transducer.
B1LP	Low pressure switch circuit 1	Refrigerant charge leakage.	Find leakage and repair.
b1IP	Low pressure transducer alarm circuit 1	Transducer defect	Replace the faulty transducer.
b1tF	Overload source fan alarm	Fan input current outside operation limits.	Check the proper operation of the source fan and, in case replace it.
C1tr	Compressor 1 overload	Compressor 1 input current outside operation limits.	Replace the compressor.
C2tr	Compressor 2 overload	Compressor 1 input current outside operation limits.	Replace the compressor.

10. DIMENSIONAL DRAWING



Dimensional drawings are to be considered indicative and not binding, therefore it is always necessary to request the definitive dimensional drawing before setting up the installation of the unit.

RAH 402-502 MC VS U Kp

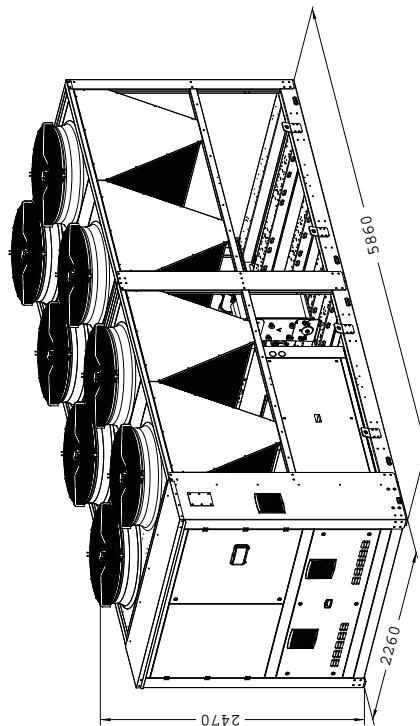
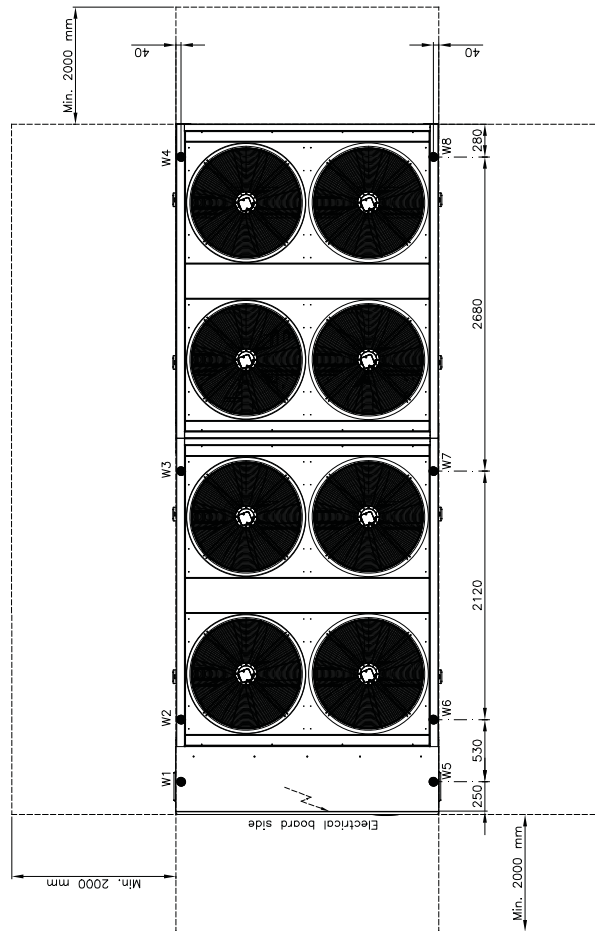

Version	RAH 402 MC SV U Kp	RAH 502 MC SV U Kp
Global weight (Kg)	3648	3898
Point W1 (Kg)	456	485
Point W2 (Kg)	500	541
Point W3 (Kg)	464	489
Point W4 (Kg)	404	434
Point W5 (Kg)	456	485
Point W6 (Kg)	500	541
Point W7 (Kg)	464	489
Point W8 (Kg)	404	434

RAH 602 MC VS U Kp

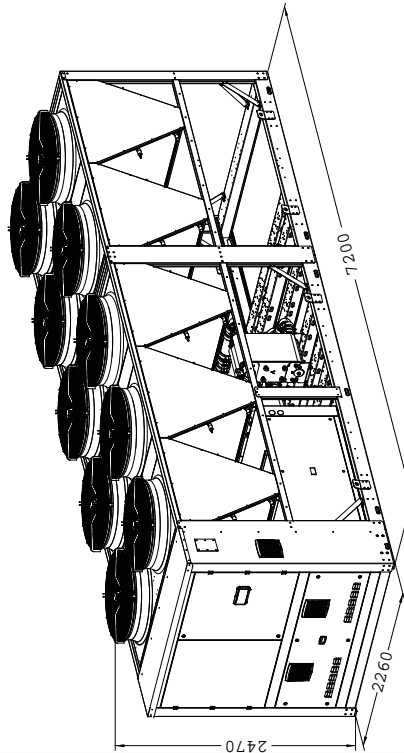
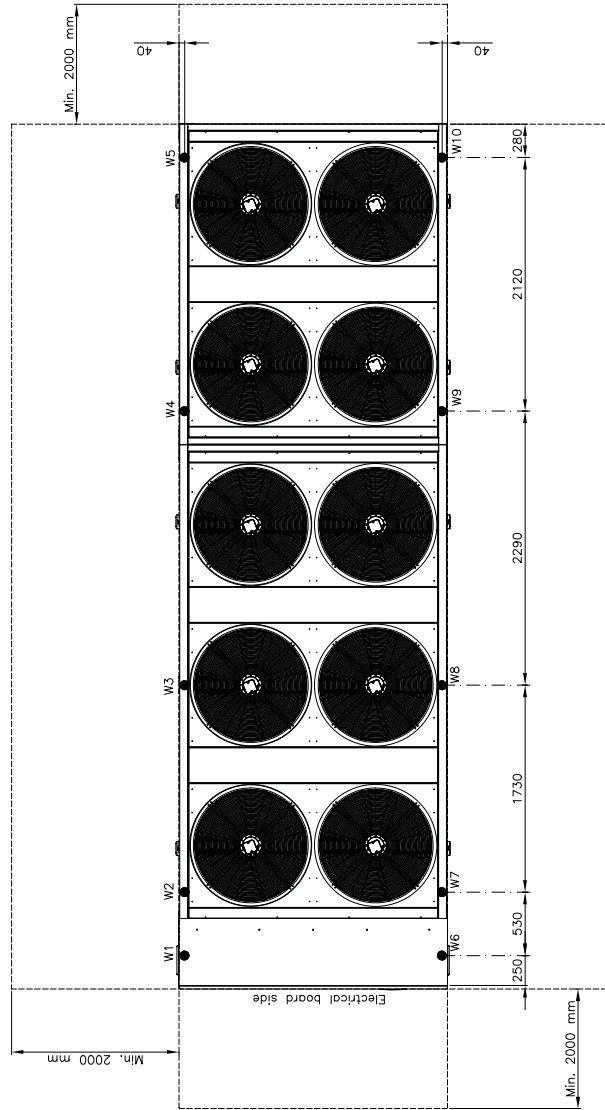

RAH602.MC.SV.U.KP	
Version	STD
Global weight (Kg)	5078
Point W1 (Kg)	565
Point W2 (Kg)	599
Point W3 (Kg)	538
Point W4 (Kg)	434
Point W5 (Kg)	403
Point W6 (Kg)	565
Point W7 (Kg)	599
Point W8 (Kg)	538
Point W9 (Kg)	434
Point W10 (Kg)	403

RAH 652-752 MC VS U Kp

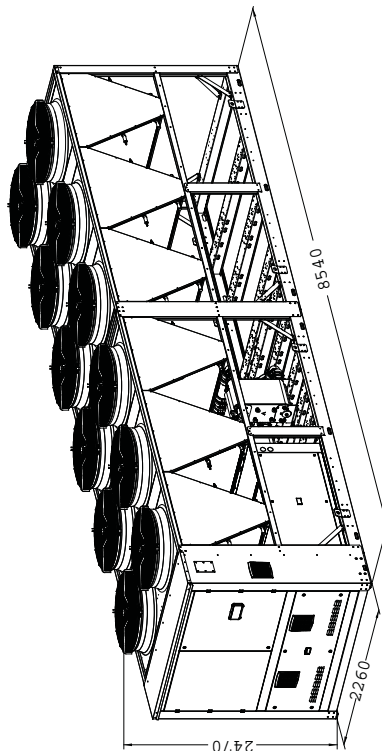
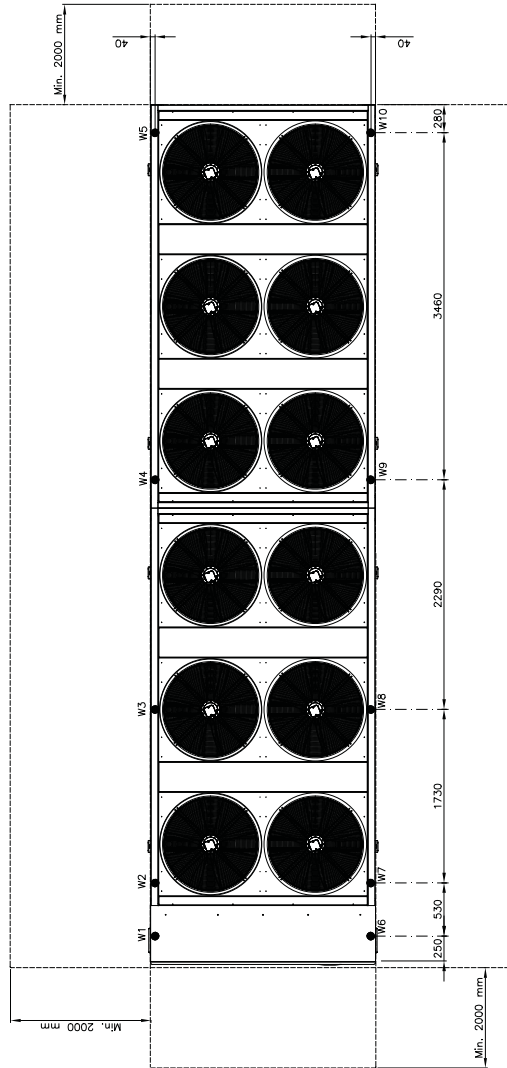

Version	STD	STD	RAH 652 MC VS U Kp	RAH 752 MC VS U Kp
Global weight (Kg)	5456	5626		
Point W1 (Kg)	603	619		
Point W2 (Kg)	640	659		
Point W3 (Kg)	581	595		
Point W4 (Kg)	464	481		
Point W5 (Kg)	440	459		
Point W6 (Kg)	603	619		
Point W7 (Kg)	640	659		
Point W8 (Kg)	581	595		
Point W9 (Kg)	464	481		
Point W10 (Kg)	440	459		



ESEX TECHNOLOGIES

VIA DELLE INDUSTRIE, 7 • CAP 31030 • VACIL DI BREDA DI PIAVE (TV)
TEL. +39 0422 605 311

Info@enextechnologies.com • www.enextechnologies.com

Technical data shown in this booklet are not binding.

The Company shall have the right to introduce at any time whatever modifications necessary to the improvement of the product.
The reference languages for the whole documentation are Italian and English. The other languages are to be considered only as guidelines.

